

Models MV1004/MV1006/MV1008/MV1012/MV1024

**MV1000  
First Step Guide**



# User Registration

Thank you for purchasing YOKOGAWA products.

We invite you to register your products in order to receive the most up to date product information. To register, visit the following URL, or click the "Product Registration" button in the opening screen of the Manual CD-ROM.

***<http://www.yokogawa.com/ns/reg/>***

# Contents

---

Foreword.....	5
Safety Precautions.....	6
Handling Precautions of the MV .....	8
CF Card Handling Precautions .....	8
Protection of Environment .....	9
<b>Checking the Contents of the Package .....</b>	<b>11</b>
<b>How to Use This Manual .....</b>	<b>14</b>
Conventions Used in This Manual .....	14
Opening the Electronic Manuals .....	14
<b>Names of Parts .....</b>	<b>15</b>
Front .....	15
Rear Panel .....	15
<b>Basic Operation .....</b>	<b>16</b>
Panel Keys.....	16
Display .....	16
Entering Values and Characters .....	17
<b>MV1000 Workflow .....</b>	<b>19</b>
<b>Installation.....</b>	<b>20</b>
Location .....	20
Installation.....	21
<b>Connecting Input Cables .....</b>	<b>22</b>
⚠ Wiring to the Signal Input Terminals .....	22
Wiring Precautions.....	22
Wiring Procedure .....	23
<b>Connecting a Power Cable .....</b>	<b>26</b>
⚠ Connecting the Power Cord (if the power supply voltage suffix code is -1).....	26
⚠ Connecting the Power Cord (if the power supply voltage suffix code is -2).....	27
When Using an AC Adapter.....	27
When Using a DC Power Supply.....	28
⚠ Turning the Power ON/OFF .....	29
<b>Quick Settings .....</b>	<b>30</b>
Procedure .....	30
<b>Measurement .....</b>	<b>32</b>
⚠ Inserting the CF Card .....	32
Starting the Memory Sample .....	33
Stopping the Memory Sample .....	33
Removing the CF Card .....	34
Viewing Data with DAQSTANDARD .....	34
<b>Default MV1000 Settings.....</b>	<b>36</b>
Setting Mode Settings and Default Values.....	38
Basic Setting Mode Settings and Default Values.....	48

## Contents

---

### **MV1000/MV2000 User's Manual (Electronic Manual Provided on the Accompanying CD)**

- Chapter 1 Feature Overview
- Chapter 2 Installation and Wiring
- Chapter 3 Measurement Channels and Alarms
- Chapter 4 Measurement and Recording
- Chapter 5 Screen Operations
- Chapter 6 Display Configuration
- Chapter 7 Event Action
- Chapter 8 Security Functions
- Chapter 9 Environment Settings
- Chapter 10 Computation and Report Functions (/M1 and /PM1 Options)
- Chapter 11 External Input Channels (/MC1 Option)
- Chapter 12 Troubleshooting and Maintenance
- Chapter 13 Specifications

### **MV1000/MV2000 Communication Interface User's Manual (Electronic Manual Provided on the Accompanying CD)**

- Chapter 1 Overview of Communication Functions
- Chapter 2 Using the Ethernet Interface
- Chapter 3 Using the Serial Interface
- Chapter 4 Commands
- Chapter 5 Responses
- Chapter 6 Status Reports
- Chapter 7 Specifications

---

## Foreword

Thank you for purchasing the MV 1000 (hereafter referred to as the MV). This manual explains the minimum steps required to start measuring quickly. It also contains a list of default MV1000 settings. Please keep it for reference. The following five manuals are provided as MV1000 manuals.

### Paper Manual

Manual Title	Manual No.	Description
MV1000 First Step Guide	IM MV1000-02E	This manual. It is also provided in the CD.
Control of Pollution Caused by the Product	IM MV1000-91C	Gives a description of pollution control.

### Electronic Manuals Provided on the Accompanying CD

Manual Title	Manual No.	Description
MV1000 First Step Guide	IM MV1000-02E	This is the electronic version of the paper manual.
MV1000/MV2000 User's Manual	IM MV1000-01E	Describes how to use the convenient functions of the MV1000. The communication function is covered in another manual.
MV1000/MV2000 Communication Interface User's Manual	IM MV1000-17E	Describes how to use the communication functions with the Ethernet and serial interfaces.
DAQSTANDARD User's Manual	IM 04L41B01-61E	Describes how to use the accompanying software program, DAQSTANDARD.

## Notes

- The contents of this manual are subject to change without prior notice as a result of continuing improvements to the instrument's performance and functions.
- Every effort has been made in the preparation of this manual to ensure the accuracy of its contents. However, should you have any questions or find any errors, please contact your nearest YOKOGAWA dealer.
- Copying or reproducing all or any part of the contents of this manual without YOKOGAWA's permission is strictly prohibited.
- The TCP/IP software of this product and the document concerning the TCP/IP software have been developed/created by YOKOGAWA based on the BSD Networking Software, Release 1 that has been licensed from the Regents of the University of California.

## Trademarks

- MVAdvanced is a trademark of Yokogawa Electric Corporation.
- Microsoft and Windows are either registered trademarks or trademarks of Microsoft Corporation in the United States and/or other countries.
- Adobe and Acrobat are either registered trademarks or trademarks of Adobe Systems Incorporated in the United States and/or other countries.
- Company and product names that appear in this manual are registered trademarks or trademarks of their respective holders.
- In this manual, the ™ and © symbols do not accompany trademarks or registered trademarks.

## Revisions

December 2007 1st Edition

---

## Safety Precautions

- This instrument conforms to IEC safety class I (provided with terminal for protective grounding), Installation Category II, and EN61326-1 (EMC standard), Measurement Category II (CAT II)\*.  
\* Measurement category II (CAT II) applies to measuring circuits connected to low voltage installation, and electrical instruments supplied with power from fixed equipment such as electric switchboards.
- This instrument is an EN61326-1 (EMC standard) class A instrument (for use in commercial, industrial, or business environments).
- The general safety precautions described here must be observed during all phases of operation. If the MV is used in a manner not described in this manual, the MV safety features may be impaired. Yokogawa Electric Corporation assumes no liability for the customer's failure to comply with these requirements.
- The MV is designed for indoor use.
- **About This Manual**
  - Please give this manual to the end user. We also ask you to store this manual in a safe place.
  - Read this manual thoroughly and have a clear understanding of the product before operation.
  - This manual explains the functions of the product. It does not guarantee that the product will suit a particular purpose of the user.
- **Precautions Related to the Protection, Safety, and Alteration of the Product**

The following safety symbols are used on the product and in this manual.



“Handle with care.” To avoid injury and damage to the instrument, the operator must refer to the explanation in the manual.



Protective ground terminal



Functional ground terminal (Do not use this terminal as a protective ground terminal.)



Alternating current



Direct current



ON (power)



OFF (power)

- For the protection and safe use of the product and the system in which this product is incorporated, be sure to follow the instructions and precautions on safety that are stated in this manual whenever you handle the product. Take special note that if you handle the product in a manner that violates these instructions, the safety features of the product may be damaged or impaired. In such cases, YOKOGAWA does not guarantee the quality, performance, function, or safety of the product.
- When installing protection and/or safety circuits such as lightning protection devices and equipment for the product and its control system or designing or installing separate protection and/or safety circuits for fool-proof design and fail-safe design of the processes and lines that use the product and the control system, the user should implement these using additional devices and equipment.
- If you are replacing parts or consumable items of the product, make sure to use parts specified by YOKOGAWA.
- This product is not designed or manufactured to be used in critical applications that directly affect or threaten human lives. Such applications include nuclear power equipment, devices using radioactivity, railway facilities, aviation equipment, air navigation facilities, aviation facilities, and medical equipment. If so used, it is the user's responsibility to include a system of additional equipment and devices that ensures safety.
- Do not modify this product.

---

---

## WARNING

- **Use the Correct Power Supply**  
Ensure that the source voltage matches the voltage of the power supply before turning the power ON.
- **Use the Correct Power Cord and Plug**  
To prevent electric shock or fire, be sure to use the power cord supplied by YOKOGAWA. The main power plug must be plugged into an outlet with a protective ground terminal. Do not disable this protection by using an extension cord without protective grounding.
- **Connect the Protective Grounding Terminal**  
Make sure to connect the protective grounding before turning the power ON, to prevent electric shock. The power cord that comes with the desktop type is a three-pronged power cord. Connect the power cord to a properly grounded three-prong outlet.
- **Do Not Impair the Protective Grounding**  
Never cut off the internal or external protective grounding wire or disconnect the wiring of the protective grounding terminal. Doing so invalidates the protective functions of the instrument and poses a potential shock hazard.
- **Do Not Operate with Defective Protective Grounding**  
Do not operate the instrument if the protective grounding might be defective. Make sure to check it before operation.
- **Do Not Operate in an Explosive Atmosphere**  
Do not operate the instrument in the presence of flammable liquids or vapors. Operation in such an environment constitutes a safety hazard.  
Prolonged use in a highly dense corrosive gas (H<sub>2</sub>S, SO<sub>x</sub>, etc.) will cause a malfunction.
- **Do Not Remove Covers**  
The cover should be removed by YOKOGAWA's qualified personnel only. Opening the cover is dangerous, because some areas inside the instrument have high voltages.
- **Ground the Instrument before Making External Connections**  
Connect the protective grounding before connecting to the item under measurement or the control unit.
- **Damage to Safety Features**  
Operating the instrument in a manner not described in this manual may damage the instrument's safety features.

---

---

## CAUTION

This is a Class A instrument. Operation of this equipment in a residential area can cause radio interference, in which case users will be required to correct the interference.

- 
- 
- **Exemption from Responsibility**
    - YOKOGAWA makes no warranties regarding the product except those stated in the WARRANTY that is provided separately.
    - YOKOGAWA assumes no liability to any party for any loss or damage, direct or indirect, caused by the user or any unpredictable defect of the product.

---

- **Handling Precautions of the Software**

- YOKOGAWA makes no warranties regarding the software accompanying this product except those stated in the WARRANTY that is provided separately.
- Use the software on a single PC.
- You must purchase another copy of the software, if you are to use the software on another PC.
- Copying the software for any purposes other than backup is strictly prohibited.
- Please store the original media containing the software in a safe place
- Reverse engineering, such as decompiling of the software, is strictly prohibited.
- No portion of the software supplied by YOKOGAWA may be transferred, exchanged, or sublet or leased for use by any third party without prior permission by YOKOGAWA.

## **Handling Precautions of the MV**

- Use care when cleaning this instrument, especially its plastic parts. Use a soft dry cloth. Do not use organic solvents, such as benzene or thinner, or other cleansers. They may cause discoloring and deformation.
- The carrying handle should only be used to carry the instrument.
- Keep electrically charged objects away from the signal terminals. If you do not, the MV may malfunction.
- Do not apply volatile chemicals to the display, panel keys, etc. Do not allow rubber and vinyl products to remain in contact with the MV for long periods of time. If you do, the MV may malfunction.
- When not in use, make sure to turn OFF the power switch.
- If there are any symptoms of trouble such as strange odors or smoke coming from the MV, immediately turn OFF the power switch and the power supply source. Then, contact your nearest YOKOGAWA dealer.

## **CF Card Handling Precautions**

- The CF card is delicate and should be handled with caution.
- Write operations to the CF card may fail if it is operated in a high-temperature or low-temperature environment. If you are operating in a low temperature environment (about 10°C or less), wait for the MV to warm up (30 minutes or more) before using it. If you are operating in a high temperature environment (about 40°C), we recommend that you insert the CF card into the drive when saving data, and remove it after the data has been saved.
- Remove the CF card from the drive when switching the MV ON/OFF.
- Touching the compact flash section when static electricity is built up on the human body can lead to erroneous operation.

---

### **CAUTION**

- Do not remove the CF card while the access indicator is illuminated. This can damage the data.
  - Do not use the CF card in a place subject to vibrations or shock. The CF card or drive may malfunction.
-



---

## Protection of Environment

Control of Pollution Caused by the Product



For details, see *Control of Pollution Caused by the Product (IM MV1000-91C)*.

### Proper Disposal of This Product

This is an explanation of how to dispose of this product based on Waste Electrical and Electronic Equipment (WEEE), Directive 2002/96/EC. This directive is only valid in the EU.

- **Marking**

This product complies with the WEEE Directive (2002/96/EC) marking requirement.

The affixed product label (see below) indicates that you must not discard this electrical/electronic product in domestic household waste.



- **Product Category**

With reference to the equipment types in the WEEE directive Annex 1, this product is classified as a "Monitoring and Control instrumentation" product.

Do not dispose in domestic household waste.

To return unwanted products, contact your local Yokogawa Europe B. V. office.

---

## Memo

## Checking the Contents of the Package

Unpack the box and check the contents before operating the instrument. If some of the contents are not correct or missing or if there is physical damage, contact the dealer from which you purchased them.

### MV1000

There is a name plate on the side panel of the MV. Check that the model name and suffix code given on the name plate match those on your order.

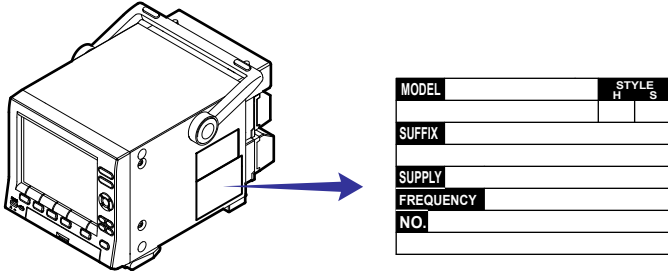

### NO. (Instrument Number)

When contacting the dealer that you purchased the instrument from, please give them the instrument number.

## Checking the Contents of the Package

### MODEL and SUFFIX Code

Model code	Suffix code	Description
MV1004		4 channel, 125 ms (fast sampling mode: 25 ms)
MV1006		6 channel, 1 s (fast sampling mode: 125 ms)
MV1008		8 channel, 125 ms (fast sampling mode: 25 ms)
MV1012		12 channel, 1 s (fast sampling mode: 125 ms)
MV1024		24 channel, 1 s (fast sampling mode: 125 ms)
Internal memory size	-1	Standard Memory
	-2	Large Memory
External storage medium	-4	CF card (with medium) and USB
Language	-2	English/German/French
	-3	Chinese
	-4	Korean
Input terminal	-1	Clamped input terminal (detachable)
	-2	Screw input terminal (M4)
Power supply	-1	100 VAC, 240 VAC
	-2	12 VDC, with AC adapter <sup>1</sup>
Power cord	D	AC power: 3-pin inlet, UL/CSA Standard power cord DC power: Screw terminal, UL/CSA cable for AC adapter
	F	AC power: 3-pin inlet, VDE Standard power cord DC power: Screw terminal, VDE cable for AC adapter
	R	AC power: 3-pin inlet, AS Standard power cord DC power: Screw terminal, AS cable for AC adapter
	Q	AC power: 3-pin inlet, BS Standard power cord DC power: Screw terminal, BS cable for AC adapter
	H	AC power: 3-pin inlet, GB (CCC) Standard power cord DC power: Screw terminal, GB (CCC) cable for AC adapter
	W	Screw terminal, without AC adapter <sup>2</sup>
Options	/A1	Two alarm output relays <sup>3,9</sup>
	/A2	Four alarm output relays <sup>3,9</sup>
	/A3	Six alarm output relays <sup>3,4,9</sup>
	/C2	RS-232 interface <sup>5</sup>
	/C3	RS-422/RS-485 interface <sup>5</sup>
	/F1	FAIL/Status output <sup>4,9</sup>
	/M1	Mathematical functions <sup>7</sup>
	/N1	Cu10, Cu25 RTD input/3-wire isolated RTD
	/N2	3-wire isolated RTD <sup>6</sup>
	/N3	Extended input type (PR40-20, JPt50, etc.)
	/R1	Remote control <sup>9</sup>
	/TPS2	24 VDC transmitter power supply (2 loops) <sup>7,9</sup>
	/PM1	Pulse input (including remote control and mathematical functions) <sup>8,9</sup>
	/CC1	Calibration correction function

1 Does not come with an AC adapter if the power cord suffix code is W.

2 Can be selected if the supply voltage suffix code is -2.

3 The /A1, /A2, and /A3 options cannot be combined.

4 The /A3 and /F1 options cannot be combined.

5 The /C2 and /C3 options cannot be combined.

6 The /N2 option is available with the MV1006, MV1012, and MV1024.





7 The /A2, /A3, /F1, and /PM1 options cannot be combined with the /TPS2 option.

8 The /A3, /M1, /R1, and /TPS2 options cannot be combined with the /PM1 option. If the /PM1 option is selected, the /A2 and /F1 options cannot be combined with each other.

9 The /A1, /A2, /A3, /F1, /R1, /TPS2, and /PM1 options are not available with the MV1008 and MV1024.

**Standard Accessories**

The standard accessories below are supplied with the instrument. Check that all contents are present and undamaged.

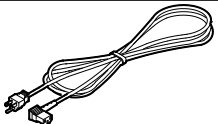
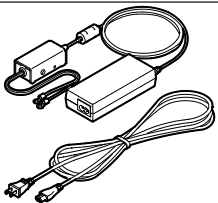
No.	Name	Part Number/ Model	Qty.	Notes
	Terminal screws	E9655FX	5	M4 (spare)
	DAQSTANDARD	MVA120	1	MV configuration and data display software
	MV1000 First Step Guide (this manual)	IM MV1000-02	1	Paper size: A4
	Proper disposal	IM MV1000-91C	1	
	User's Manuals for the MV1000/ MV2000	B8806ZZ	1	A CD with a PDF file of the MV1000/MV2000 User's Manual and a PDF file of the Communication Interface User's Manual.
	CF card	B8706NQ	1	128 MB (size and model are subject to change)
	Power cord			When the supply voltage suffix code is -1, one of the following cables is included, depending on the power cable suffix code.
		A1074WD	1	Power cord suffix code D. Maximum rated voltage: 125 V
		A1009WD	1	Power cord suffix code F. Maximum rated voltage: 250 V
		A1024WD	1	Power cord suffix code R. Maximum rated voltage: 250 V
		A1054WD	1	Power cord suffix code Q. Maximum rated voltage: 250 V
		A1064WD	1	Power cord suffix code H. Maximum rated voltage: 250 V
	AC adapter and power cord for AC adapter	B8805GV	1	Only included if the supply voltage suffix code is -2 (except for power cord suffix W). When the supply voltage suffix code is -2, one of the following cables is included, depending on the power cable suffix code.
		B9988YA	1	Power cord suffix code D. Maximum rated voltage: 125 V
		B9988YB	1	Power cord suffix code F. Maximum rated voltage: 250 V
		B9988YC	1	Power cord suffix code R. Maximum rated voltage: 250 V
		A1069WD	1	Power cord suffix code Q. Maximum rated voltage: 250 V
		B9988YJ	1	Power cord suffix code H. Maximum rated voltage: 250 V

**Optional Accessories (Sold Separately)**

The following optional accessories are available for purchase separately. If you ordered any optional accessories, make sure that they are present and undamaged. For information about ordering accessories, contact your nearest YOKOGAWA dealer.

No.	Name	Model	Minimum	Notes
1	CF card	772091	1	128 MB
		772092	1	256 MB
		772093	1	512 MB
		772094	1	1 GB
2	CF card adapter	772090	1	—
3	Shunt resistor (for screw input terminal)	415920	1	250 Ω ± 0.1%
		415921	1	100 Ω ± 0.1%
		415922	1	10 Ω ± 0.1%
4	Shunt resistor (for clamped input terminal)	438920	1	250 Ω ± 0.1%
		438921	1	100 Ω ± 0.1%
		438922	1	10 Ω ± 0.1%
5	Clamp terminal	A1923JT	1	Can be used with models that have an input terminal suffix code of -1.

# How to Use This Manual

## Conventions Used in This Manual

- This user's manual assumes that the display language is set to English (language suffix code -2).
- For information on setting the display language, see section 9.4, "Changing the Display Language" in the *MV1000/MV2000 User's Manual (IM MV1000-01E)*.

### Unit

K stands for 1024. Example: 768 KB (file size)  
k stands for 1000.

### Markings

The following safety notations are used in this manual.



*Improper handling or use can lead to injury to the user or damage to the instrument.* This symbol appears on the instrument to indicate that the user must refer to the user's manual for special instructions. The same symbol appears in the corresponding place in the user's manual to identify those instructions. In the manual, the symbol is used in conjunction with the word "WARNING" or "CAUTION."

### WARNING

Calls attention to actions or conditions that could cause serious or fatal injury to the user, and precautions that can be taken to prevent such occurrences.

### CAUTION

Calls attentions to actions or conditions that could cause light injury to the user or damage to the instrument or user's data, and precautions that can be taken to prevent such occurrences.

### Note

Calls attention to information that is important for proper operation of the instrument.



This mark is used to indicate a reference to a related procedure or explanation.

### Bold characters

Bold characters are used to indicate text that appears on the screen or operation keys.

## Opening the Electronic Manuals

The accompanying CD contains PDF files of the manuals. When you load the CD into the CD-ROM drive on your PC, a startup screen appears. Click the manual title to open the respective manual.

If the startup screen does not appear, double-click MV\_manual in My Computer, and open the manuals in the English directory.

# Names of Parts

## Front

With the cover open

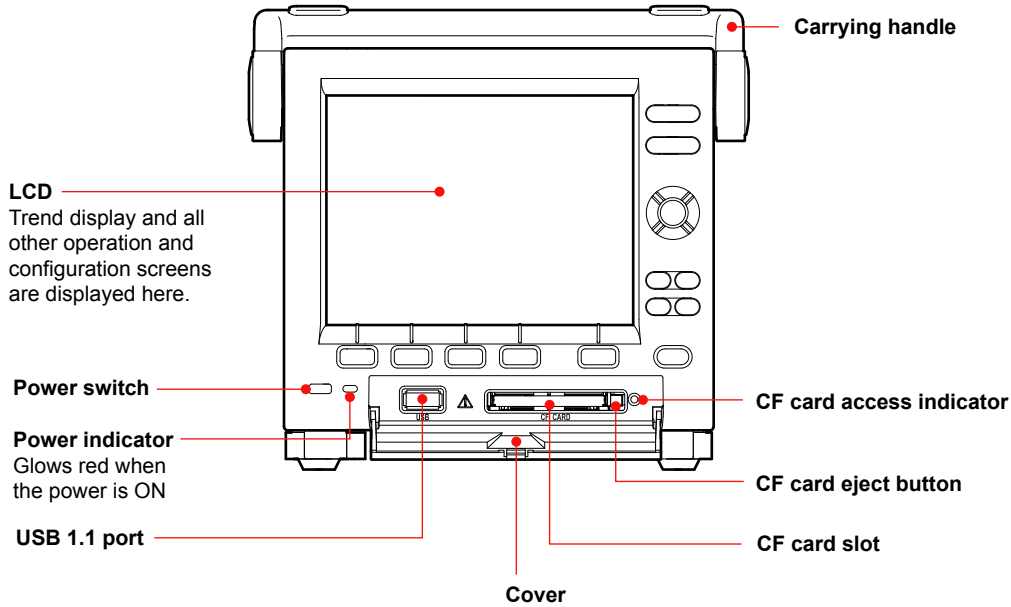

## Rear Panel

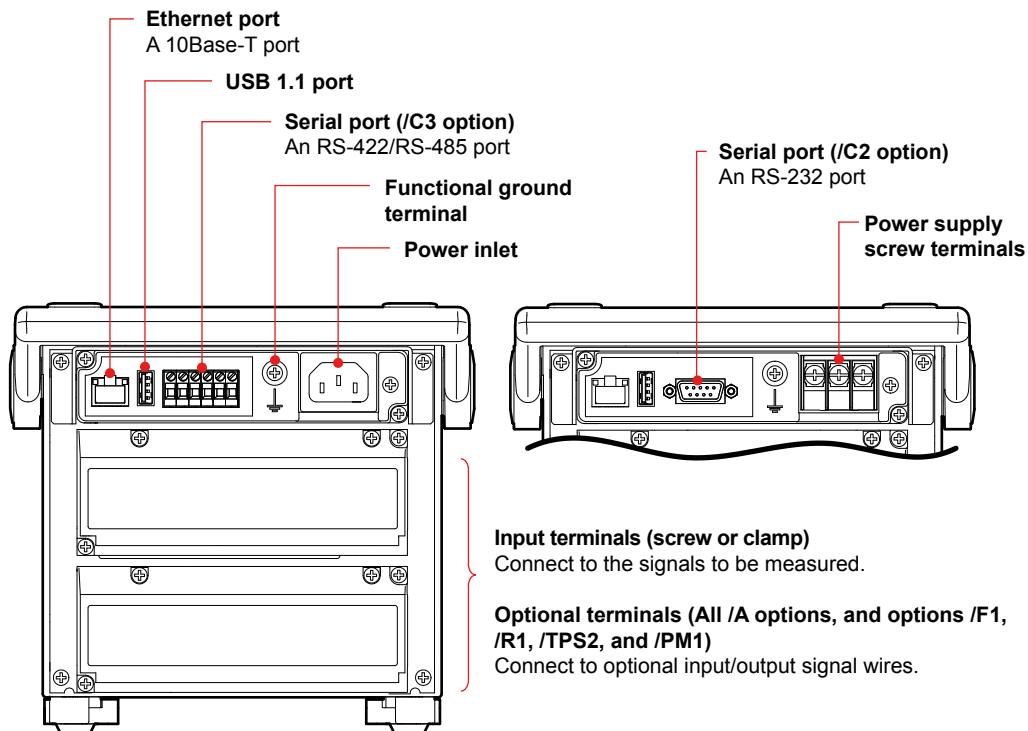

# Basic Operation

## Panel Keys

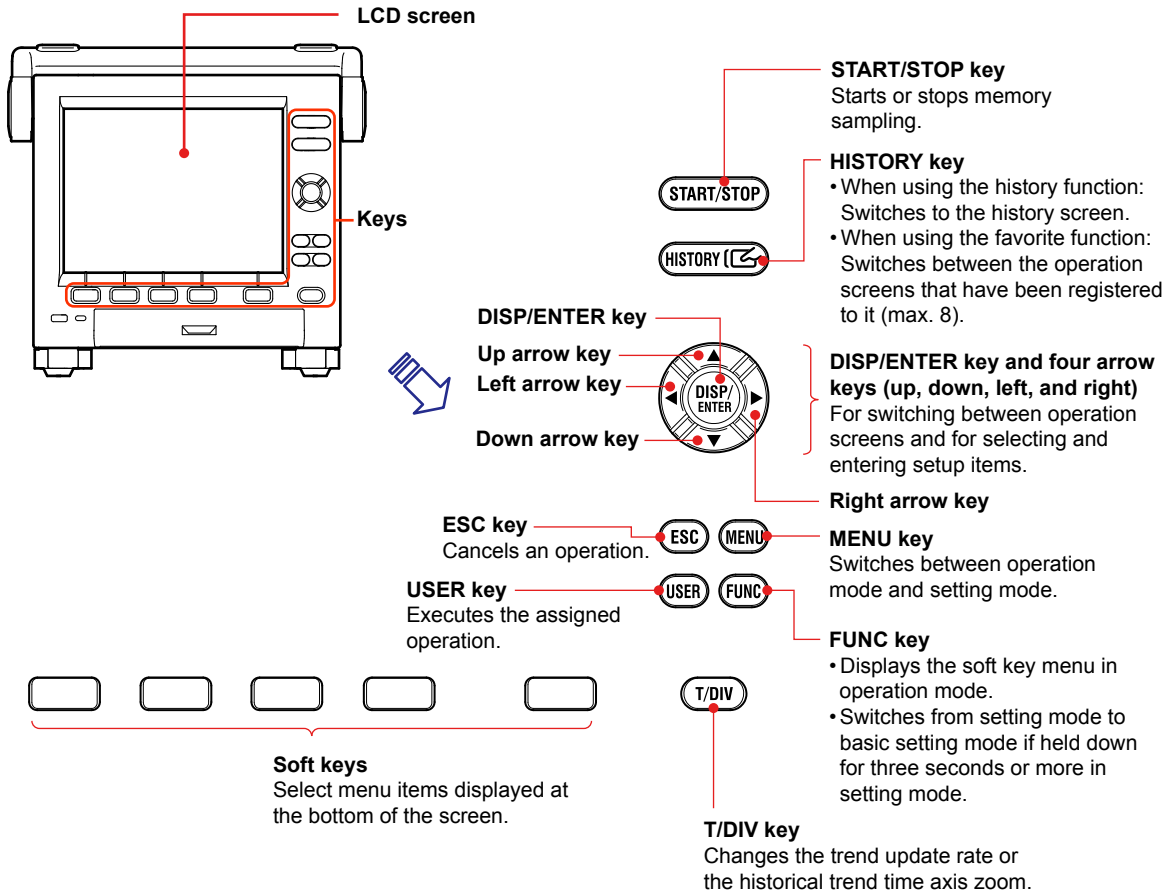

## Terminology

Word	Definition
Memory sampling	Recording measured data.
Memory start	A command to start memory sampling.
Memory stop	A command to stop memory sampling.
Display data	The waveform data displayed on the MV screen. It is essentially measured data that is recorded at the display data sampling rate.
Event data	Measured data that is recorded at a set sampling rate that differs from that of the display data.

## Display

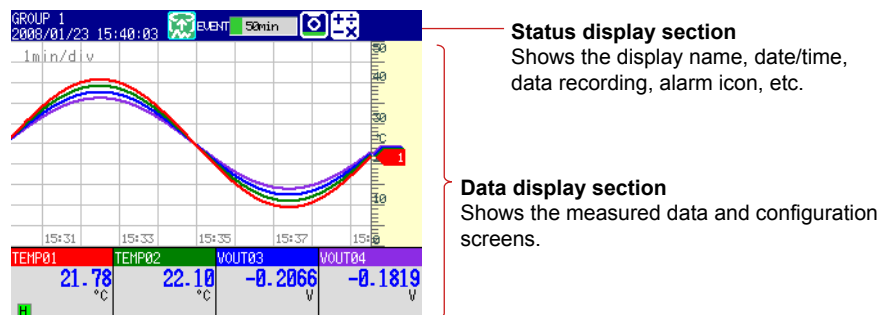



## Entering Values and Characters

The character/number input window and DISP/ENTER key are used to set the date/time, set the display span of the input range, set tags, set message strings, enter passwords, etc.

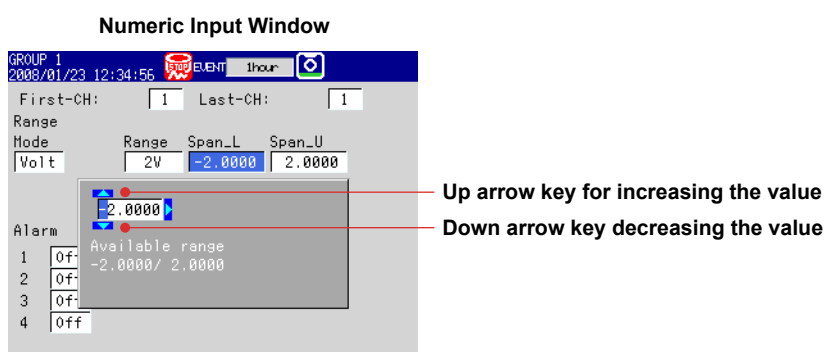
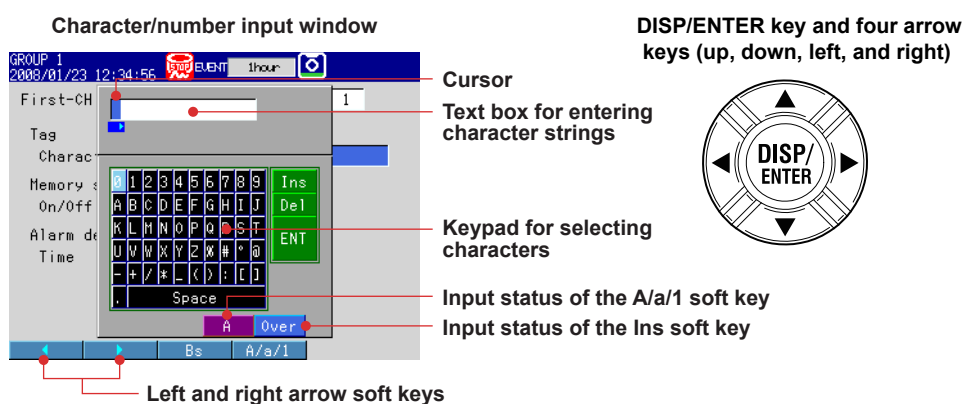

## Entering Character Strings

Use the following keys when a window for entering a character string appears.

- Left and right arrow soft keys: Move the cursor in the text box to select the input position.
- Keypad: Use the four arrow keys (up, down, left, and right) to move the cursor on the keypad to select the desired character.  
 Ins: Switches between insert and overwrite.  
 Del: Deletes the character at the cursor position in the text box.  
 ENT: Enters the character string in the text box.
- DISP/ENTER key: Enters the character that you selected with the keypad into the text box or executes Ins, Del, or ENT.
- Bs soft key: Deletes the character before the cursor position.
- A/a/1 soft key: Selects uppercase alphabet (A), lowercase alphabet (a), or value (1)  
 The character type that you can enter changes each time you press the A/a/1 soft key. The selected character type is displayed at the bottom section of the character/number input window.

## Entering Numeric Values

You can use the following key operations when a numeric input window appears.

- Left and right arrow keys: Select the input position.
- Up and down arrow keys: Scroll to the appropriate digit.

---

## Memo

# MV1000 Workflow

To set up the MV for quick use in the field, follow these steps:

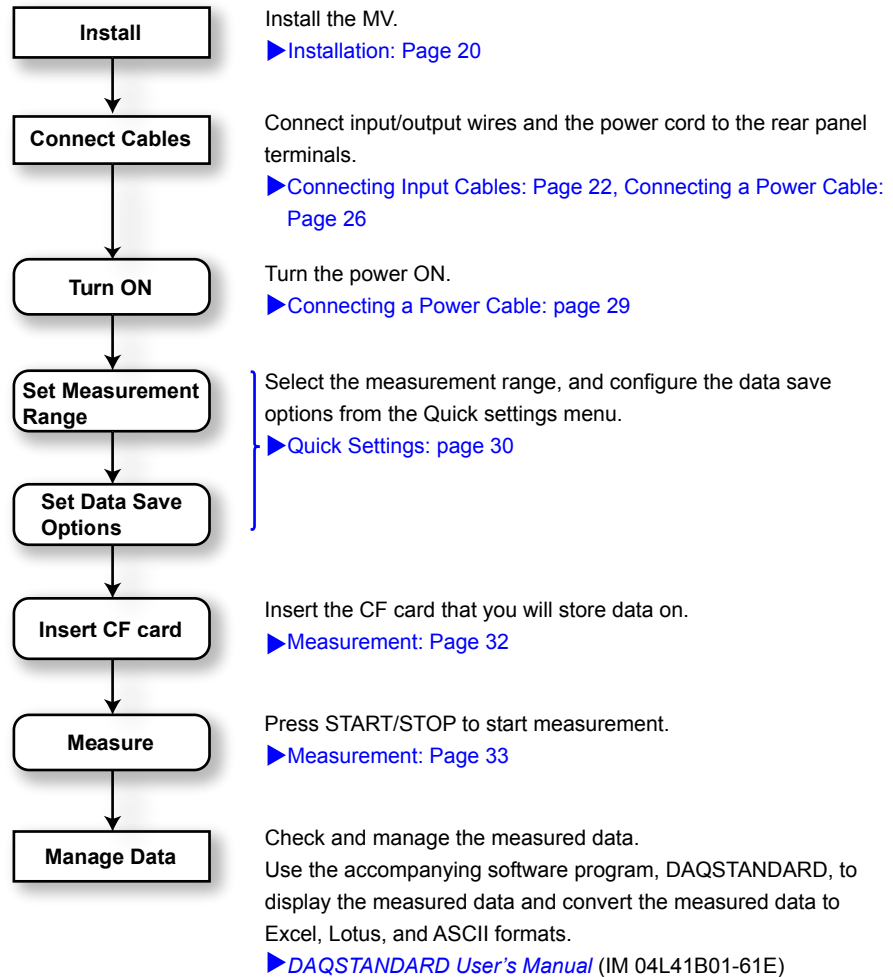

# Installation

## Location

Install the MV indoors in an environment that meets the following conditions:

- **Temperature of 0 to 40°C**

Install the MV in a location where the temperature is 0 to 40°C, and the humidity is 20 to 80% RH (5 to 40°C). Only use the MV when there is no condensation on it.

**Note**

---

Condensation may form when moving the MV from a low temperature/humidity environment to a high temperature/humidity environment, or when there is a sudden change in temperature. Temperature/humidity changes may also result in thermocouple measurement errors. In these kinds of circumstances, wait for at least an hour before using the MV, to acclimate it to the surrounding environment.

---

- **Altitude of 2,000 m or below**

- **Good ventilation**

To prevent overheating, install the MV in a well-ventilated area. We recommend that you leave 50 mm or more of space around the top, left, and right of the MV.

- **Not much mechanical vibration**

Install the MV in a location without much mechanical vibration. Placing the MV in a place that is subject to large levels of mechanical vibration will not only put added stress on its components, it may also impede ordinary measurement.

- **Flat surface**

Install the MV on a flat surface, neither leaning to the left nor to the right. The MV can be tilted if the stand is used.

Do not install the MV in the following places:

- **Outdoors**

- **In an environment with flammable or explosive gases, steam, or dust (dangerous places)**

- **In direct sunlight or near heating devices**

Install the MV in a place that is near room temperature (23°C) and that is not subject to very much temperature fluctuation. Placing the MV in direct sunlight or near heating devices can cause adverse effects on the internal circuitry.

- **In an environment with excessive amounts of soot, steam, moisture, dust, or corrosive gases**

Soot, steam, moisture, dust, and corrosive gases will adversely affect the MV and should be avoided.

- **Near strong magnetic fields**

Install the MV in a place with a magnetic field of less than 400 A/m. Do not bring magnets or instruments that produce electromagnetic fields close to the MV. Operating the MV near strong magnetic fields can cause measurement errors.

- **Where the display is difficult to see**

The MV uses an LCD screen so viewing of the display from an extreme angle is difficult. Install the MV so that the user can view the display directly from the front.

## Installation

Install the MV on a flat surface.

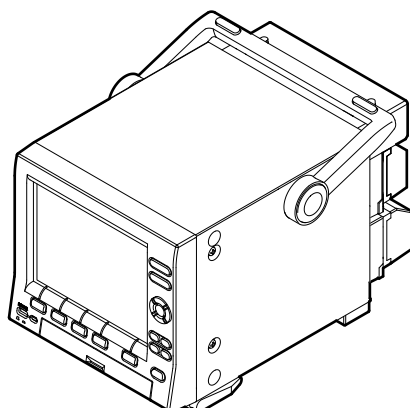

---

**Note**

You cannot put the MV in a stack.

---

- Using the stand  
When using the stand, push it out until it locks into place.

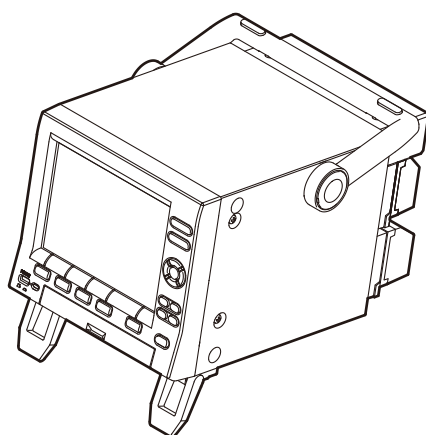

# Connecting Input Cables

## Wiring to the Signal Input Terminals



### WARNING

- To prevent electric shock, make sure that the power source is turned OFF.

### CAUTION

- Exposing the input and output signal cables connected to the MV to high tension may damage the cables and the MV terminals. Do not stretch the cables to their limit, and make sure that the terminals are not being pulled on.
- To prevent fire, only use signal cables with a temperature rating of 70°C or above.
- Do not run a current through any of the input terminals that exceeds the voltages below. Doing so may damage the MV.
  - Maximum input voltage:  $\pm 60$  VDC
  - Maximum common mode voltage:  $\pm 60$  VDC (under measurement category II conditions)
- The MV is an installation category II product.

## Wiring Precautions

Take the following precautions when wiring the input signal cables:

**When using a screw terminal, we recommend that you use a crimp-on lug with an insulation sleeve (designed for 4-mm screws).**



Crimp-on lug (designed for 4 mm screws) with an insulation sleeve

When using a clamp terminal, we recommend that you use the following kind of cable:

- Conductive cross-sectional area: 0.08 mm<sup>2</sup> to 1.5 mm<sup>2</sup> (AWG28 to 16)
- Stripped section: Approx. 7 mm

**Take measures to prevent noise from entering the measurement circuit.**

- Move the measurement circuit away from the power cable (power circuit) and ground circuit.
- Ideally, the object being measured should not generate noise. However, if this is unavoidable, isolate the measurement circuit from the object. Also, ground the object being measured.
- Shielded wires minimize the noise caused by electrostatic induction. Connect a shield to the ground terminal of the MV as necessary (make sure you are not grounding at two points).
- To minimize noise caused by electromagnetic induction, twist the measurement circuit wires at short, equal intervals.
- Make sure to ground the protective ground terminal through minimum resistance (less than 100  $\Omega$ ).

**When using internal reference junction compensation on a thermocouple input, take measures to stabilize the temperature at the input terminal.**

- Always use the terminal cover.
- Do not use thick wires which may cause large heat dissipation (we recommend a cross-sectional area of 0.5 mm<sup>2</sup> or less).
- Make sure that the ambient temperature remains reasonably stable. Large temperature fluctuations can occur if a nearby fan turns ON or OFF.

Connecting the input wires in parallel with other devices can cause signal degradation, affecting all connected devices. If you have to make a parallel connection, then

- Turn the burnout detection function OFF.
- Ground the instruments to the same point.
- Do not turn other instruments ON or OFF during operation. This can have adverse effects on the other instruments.
- Do not connect RTDs in parallel.

### Wiring Procedure

There is a terminal cover screwed onto the signal input terminal block on the rear panel. It has a label indicating the terminal arrangement on it.

1. Turn the MV OFF and remove the terminal cover.
2. Connect the signal wires to the terminals.
3. Replace the terminal cover and fasten it with screws. The appropriate tightening torque for the screws is 0.6N/m.

**Note**

It may be difficult to firmly secure input signal wires with diameters of 0.3 mm or less to clamp terminals. To secure the wires, try folding the conductive parts over when you connect them to the clamp terminal.

### Input Terminal Arrangement

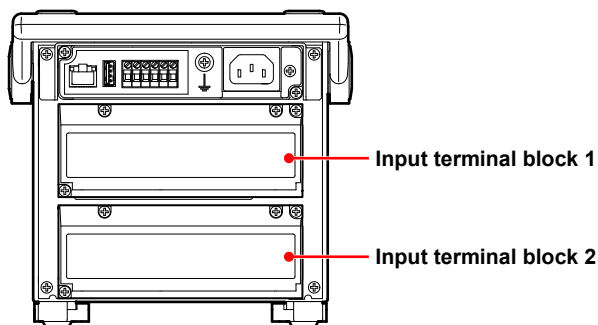

Input terminal block	Channel allocation by model				
	MV1004	MV1006	MV1008	MV1012	MV1024
1			1 to 4		1 to 12
2	1 to 4	1 to 6	5 to 8	1 to 12	13 to 24

## Connecting Input Cables

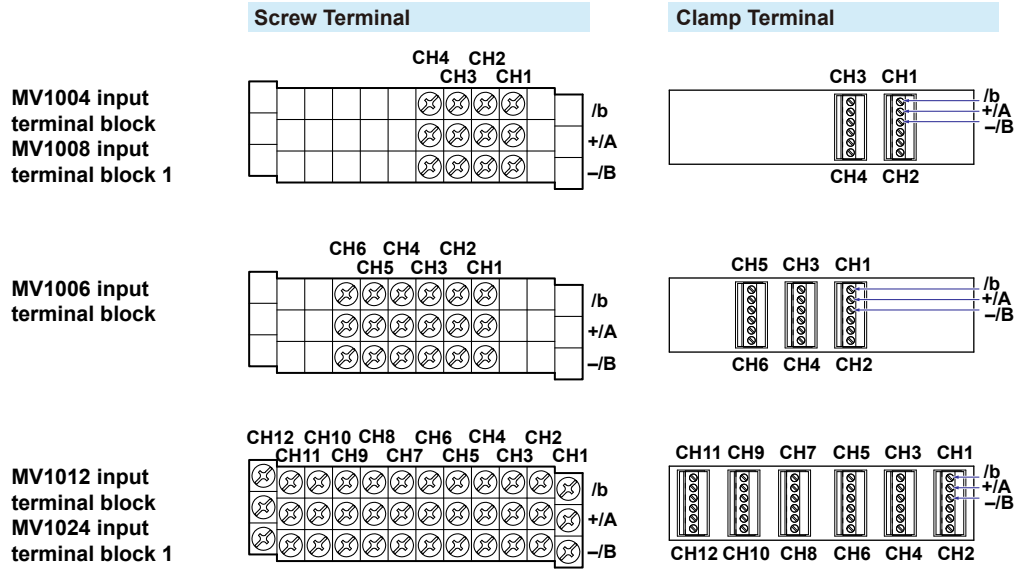

## Wiring Screw Terminals

DC voltage input/DI (ON/OFF) input

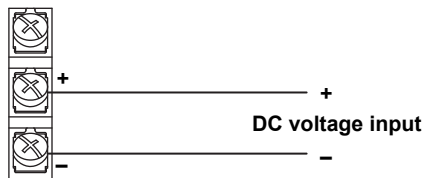

TC input

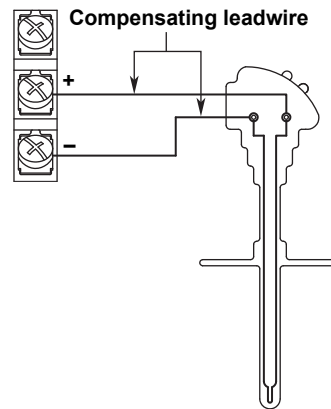

RTD input

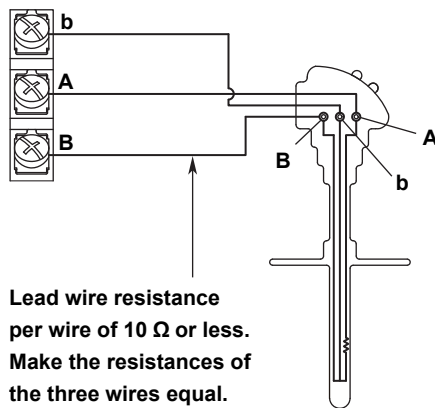

DC current input

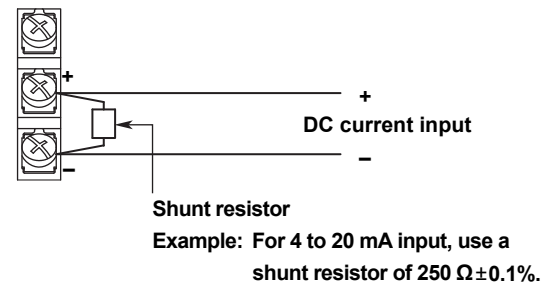



### Wiring Clamped Terminals

Remove the terminal block.

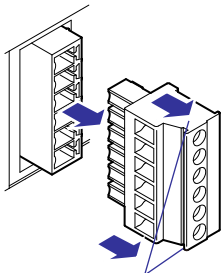

Hold both ends of the terminal block and pull straight.

Connect the wires.

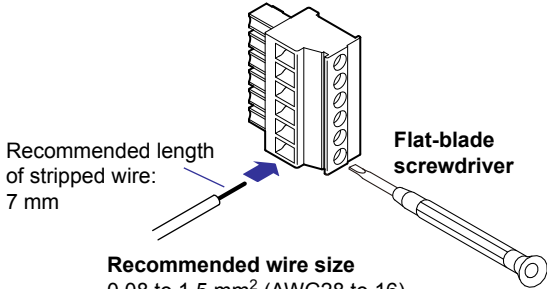

Recommended length of stripped wire: 7 mm

Flat-blade screwdriver

Recommended wire size 0.08 to 1.5 mm<sup>2</sup> (AWG28 to 16)

**Input signal wire**  
First, loosen the screw at the front using a flat-blade screwdriver. Insert the input signal wire into the slit on the left side of the terminal block, and fasten the screw at the front.

Connect the terminal block.

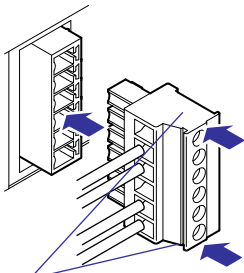

Hold both ends of the terminal block, align it with the connector, and then push it in.

**Note**

RTD input terminals A and B are isolated on each channel. Terminal b is shorted internally across all channels. However, terminal b is also isolated on each channel on models with the /N1 option (Cu10, Cu25 RTD input/3-wire isolated RTD) and /N2 option (3-wire isolated RTD).

# Connecting a Power Cable

## Connecting the Power Cord (if the power supply voltage suffix code is -1)

### Precautions to Be Taken While Connecting the Power Supply

Make sure to follow the warnings below when connecting the power supply. To prevent electric shock and damage to the MV, observe the following warnings.



### WARNING

- Before connecting the power cord, ensure that the source voltage matches the rated supply voltage of the MV and that it is within the maximum rated voltage range of the provided power cord.
- Confirm that the power switch is OFF before connecting the power cord.
- To prevent electric shock or fire, be sure to use the power cord supplied by YOKOGAWA.
- Make sure to perform protective grounding to prevent electric shock. Connect the power cord of the desktop type to a three-prong power outlet with a protective ground terminal.
- Do not use an extension cord without protective ground. Otherwise, the protection function will be compromised.

Use a power supply that meets the following conditions:

Item	Condition
Rated supply voltage	100 to 240 VAC
Allowable power supply voltage range	90 to 132, 180 to 264 VAC
Rated power supply frequency	50/60 Hz
Allowable power supply frequency range	50/60 Hz $\pm$ 2%
Maximum power consumption	45 VA (100V) and 60 VA (240 V)

### Note

Do not use a supply voltage in the range 132 to 180 VAC, as this may have adverse effects on measurement accuracy.

### Connection Procedure

1. Check that the power switch is OFF.
2. Connect the power cord plug to the power connector on the rear panel. (Use the power cord that comes with the package.)

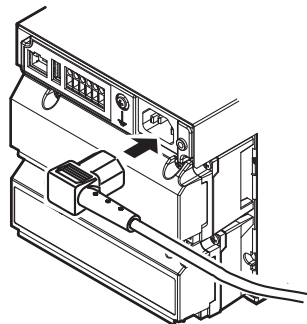

3. Check that the power outlet meets the conditions given in the table above and that the supply voltage is within the maximum rated voltage range of the power cord that comes with the package. Then, connect the other end of the power cord to the power outlet. You must use a three-prong AC outlet with a protective ground.

## Connecting the Power Cord (if the power supply voltage suffix code is -2)

### When Using an AC Adapter

#### Precautions to Be Taken While Connecting the Power Supply

Make sure to follow the warnings below when connecting the power supply. To prevent electric shock and damage to the MV, observe the following warnings.



#### WARNING

- To prevent electric shock, make sure that the power source is turned OFF.
- Only use the power cord that YOKOGAWA provides for use with the MV.
- Confirm that the power source voltage matches the specifications of the AC adapter before connecting the power cord.
- When you do not plan on using the MV for a while, remove the power cord from the AC outlet.
- Only use a YOKOGAWA AC adapter.
- Do not place objects on top of the AC adapter or power cord, and keep them away from heat sources.
- When removing the plug from the power outlet, do not pull on the cord. Pull from the plug. If the power cord is damaged, contact the dealer from whom you purchased the cord.

Use a power supply that meets the following conditions:

Item	Specifications
Rated supply voltage	100 to 240 VAC
Operating supply voltage range	90 to 264 VAC
Rated supply frequency	50/60 Hz
Power supply frequency range	48 to 62 Hz
Maximum power consumption	45 VA (100 V), 60 VA (240 V)

### Connection Procedure

1. Check that the power switch is OFF.
2. Connect the power cord and the protective ground cord to the power terminal. Use round crimp-on lugs (designed for 4-mm screws) with insulation sleeves. The appropriate tightening torque for the screws is 1.4 to 1.5 N/m.

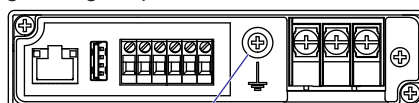

Functional ground terminal

#### Note

Do not wire the protective grounding cord to the functional ground terminal.

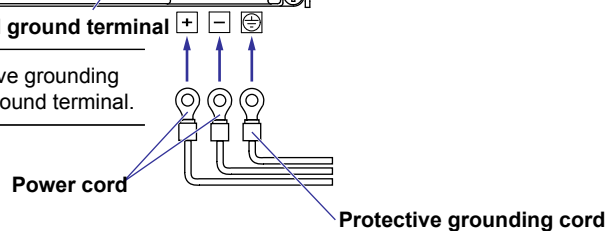

3. Attach the power terminal cover (transparent), and fasten it with screws.

### When Using a DC Power Supply

#### Precautions to Be Taken While Connecting the Power Supply

Make sure to follow the warnings below when connecting the power supply. To prevent electric shock and damage to the MV, observe the following warnings.



#### WARNING

- To prevent electric shock, make sure that the power source is turned OFF.
- To prevent fire, use cables with a cross-sectional area of 0.5 mm<sup>2</sup> (AWG20) or more.
- Use crimp-on lugs (designed for 4 mm screws) with insulation sleeves to connect both the power cord and the protective ground.
- To prevent electric shock, be sure to attach the electrical wiring cover (transparent).

---

Use a power supply that meets the following conditions:

Item	Specifications
Rated supply voltage	12 or 24 VDC
Operating supply voltage range	10 to 28.8 VDC
Maximum power consumption	24 VA

#### Connection Procedure

1. Make sure that the power source is OFF. Open the power terminal cover (transparent).
2. Follow the instructions in “When using an AC adapter” and connect the positive and negative cables and the protective ground cable to the power terminal.
3. Attach the power terminal cover (transparent), and fasten it with screws.

## Turning the Power ON/OFF

### Turning the Power ON



#### CAUTION

Before turning ON the power switch, check that

- The power cord/wires are connected correctly to the MV.
- The MV is connected to the correct power supply.

If the input wires are connected in parallel with other devices, do not turn the power switch of the MV or another device ON or OFF during operation. This can have adverse effects on the measured values.

Turn ON the power switch.

After the MV performs a self-test for a few seconds, the operation screen appears.

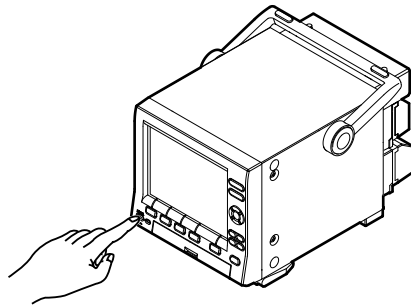

#### CAUTION

- If nothing is displayed when the power switch is turned ON, turn the power switch OFF and check the points listed above one more time. After checking the points, turn the power switch ON again. If the MV still does not work, it is probably a malfunction. Contact your nearest YOKOGAWA dealer for repairs.
- If an error message is displayed on the screen, refer to section 12.2, “Troubleshooting,” in the *MV1000/MV2000 User’s Manual*, and take the appropriate measures.
- Turn ON the power switch, let the MV warm up for at least 30 minutes, and then start measurement.

### Turning the Power OFF



#### CAUTION

Before turning OFF the power switch, check that the external storage medium is not being accessed.

Turn OFF the power switch.

# Quick Settings

Using the quick settings function, you can switch quickly to the measurement channel (measurement range and alarm) and data save configuration screens by pressing **T/DIV**.

## Procedure

Operate the MV from the Quick settings screen according to the procedure described below.

- Measurement channels: Set channels 1 through 4 to the following settings:  
Mode: Volt, Range: 2V, Span\_L: -2V, Span\_U: 2V
  - Display-data save settings: Trend/Storage interval: 1min, Save interval: 1h
  - Event data save settings: Sample rate: 1s, Mode: Free (mem. sampling started with START/STOP key), Data length: 1h
- List of default MV1000 settings: page 36

### 1 Press MENU.

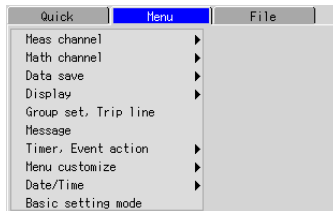

### 2 Press the left arrow key.

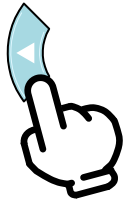

### 3 Press T/DIV.

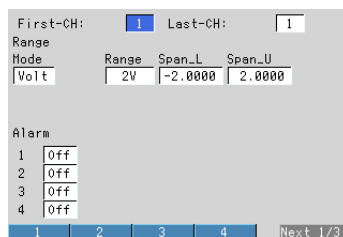

### 4 Set the measurement range

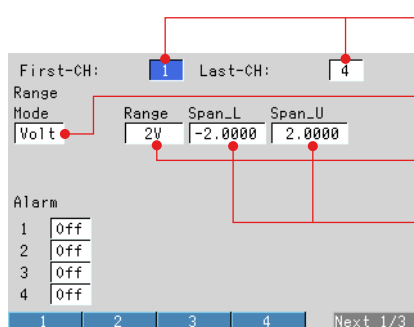

1. Select the channels to configure.  
Press **1** for the first channel and **4** for the last channel.
2. Select the **Mode**.  
Press the **Volt** soft key.
3. Select the **Range**.  
Press the **2V** soft key.
4. Enter the span upper and lower limits.  
Press the **Input** soft key, and select a value with the up and down arrow keys.

### 5 Press T/DIV

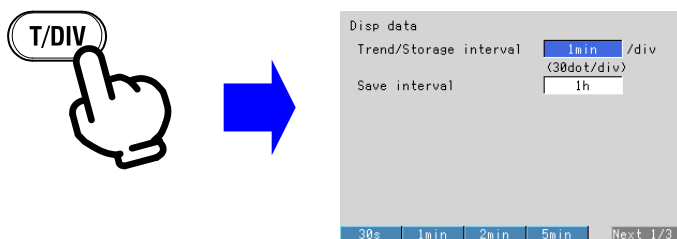

### 6 Change the display-data save settings

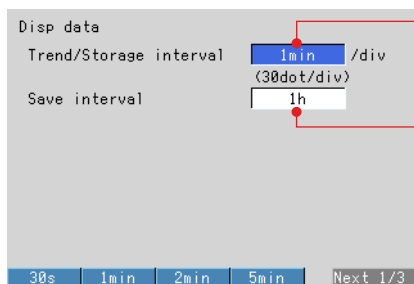

1. Select the **Trend/Storage interval**. Press the **1min** soft key.
2. Select the **Save interval**. Press the **1h** soft key.

**Note**  
This screen does not appear with the default settings. In **A/D**, **Memory** in **Basic setting mode**, set the data type to **E+D**

### 7 Press T/DIV.

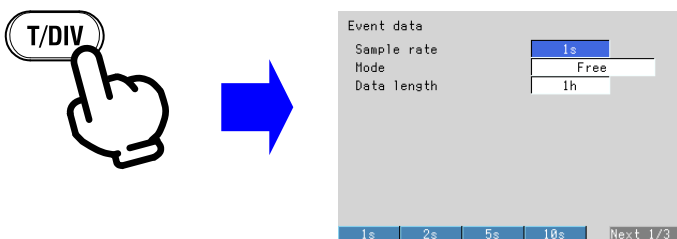

### 8 Change the event data display settings.

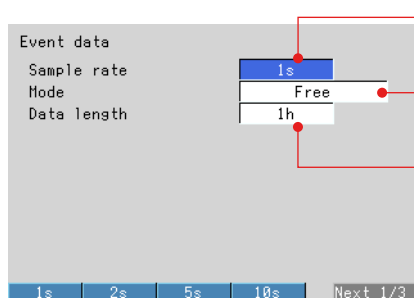

1. Select the **Sample rate**. Press the **1s** soft key.
2. Select the recording **Mode**. Press the **Free** soft key.
3. Select the **Data length**. Press the **1h** soft key.

### 9 Press T/DIV.

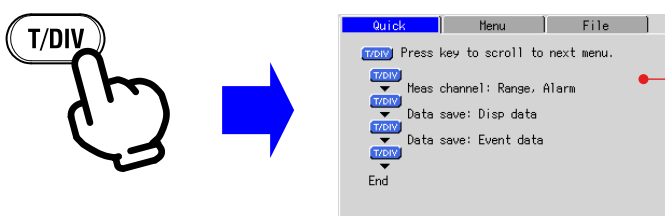

Return to the **Quick** settings screen. You have finished configuring the MV.

# Measurement

## Inserting the CF Card

1. Open the cover.

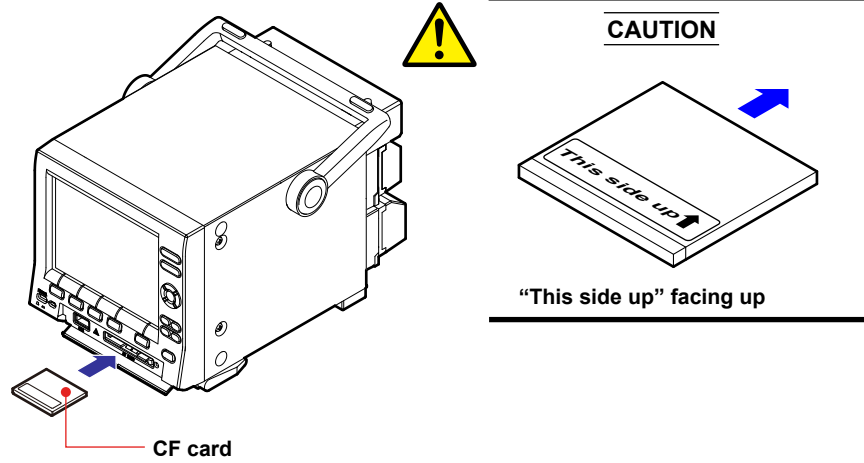

2. Insert the CF card into the slot.

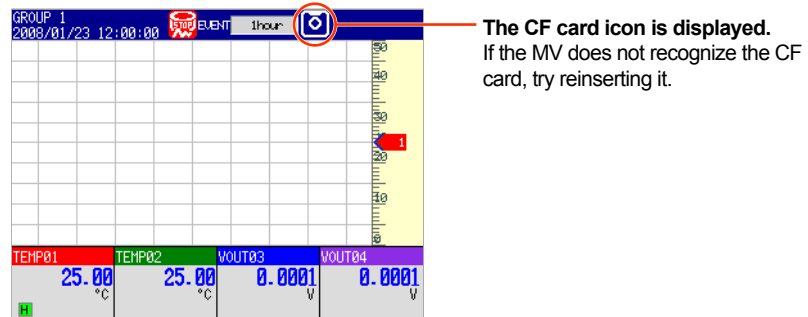

3. Close the cover.  
Check that the CF card slot eject button is depressed before closing the cover.

Operation complete.



### Starting the Memory Sample

1. Press **START/STOP** once.  
Memory sampling starts, and the key blinks green.

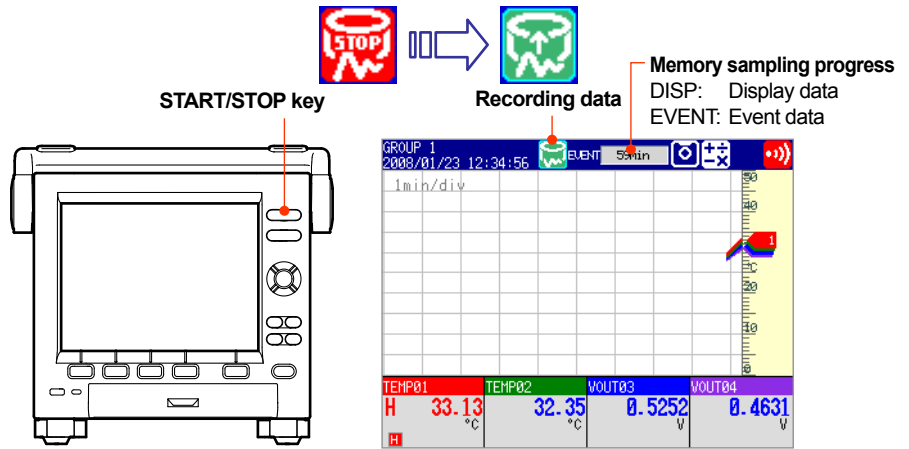

Operation complete.

### Stopping the Memory Sample

1. Press the **START/STOP** key when it is blinking green.

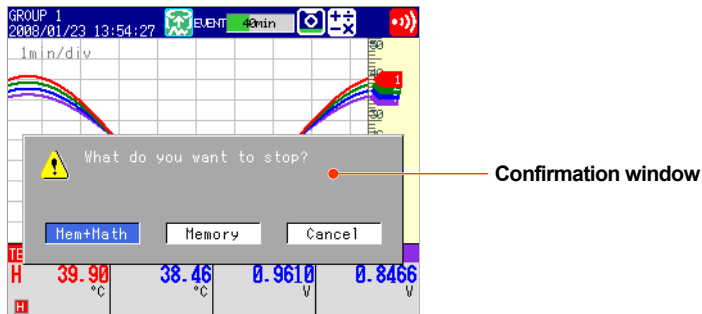

2. Select **Mem+Math** or **Memory** using the **left and right arrow keys**.  
 Memory: Stops memory sampling.  
 Mem+Math: Stops memory sampling and computation (option).  
 On models without the computation function (option), the confirmation message "Do you want to stop data storage?" appears. Select Yes.
3. Press **DISP/ENTER** once.



Operation complete.

## Removing the CF Card

1. Press **FUNC** once.
2. Press **Media eject** once.

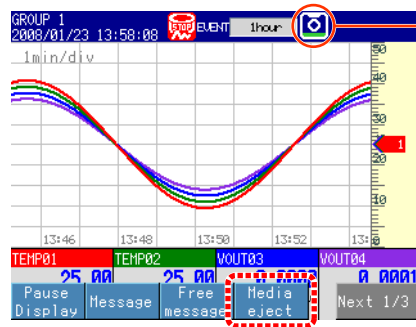

Displays the CF card icon

3. Press the **CF** soft key once. The message “Media can be removed safely” appears. The CF card icon is blue.



4. Open the cover.
5. Press the CF card eject button. When you eject the CF card, the storage media icon disappears.

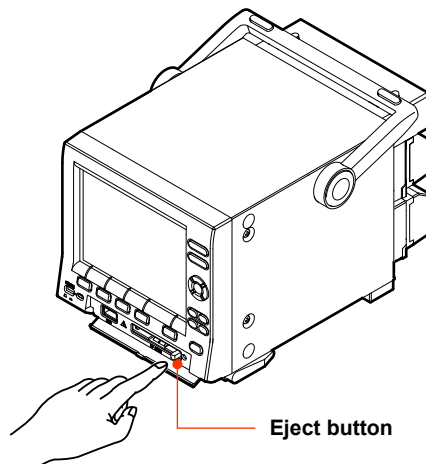

Push on the eject button until it clicks. The eject button remains depressed. Pinch the left and right sides of the CF card and remove it.

6. Close the cover.

Operation complete.

### **Note**

If you remove the CF card without carrying out the media eject procedure, the message “Media was removed compulsorily” appears. Remove the CF card by carrying out the procedure above to prevent damaging the data that is stored.

## Viewing Data with DAQSTANDARD

You can use the DAQSTANDARD software that comes with the MV1000 to view data saved to a CF card. For more information, see the *DAQSTANDARD User's Manual (IM 04L41B01-01E)*

---

## Memo

# Default MV1000 Settings

The setting mode and basic setting mode settings and their default values are listed in this section.

## Setting Mode Menu

- **Menu**

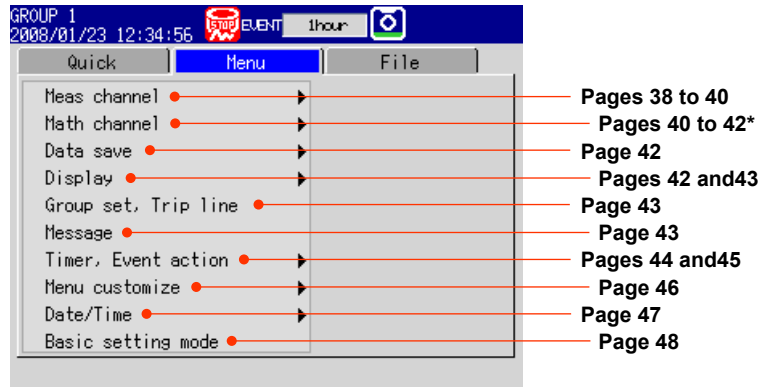

\* Optional function

## Basic Setting Mode Menu

- **Environment**

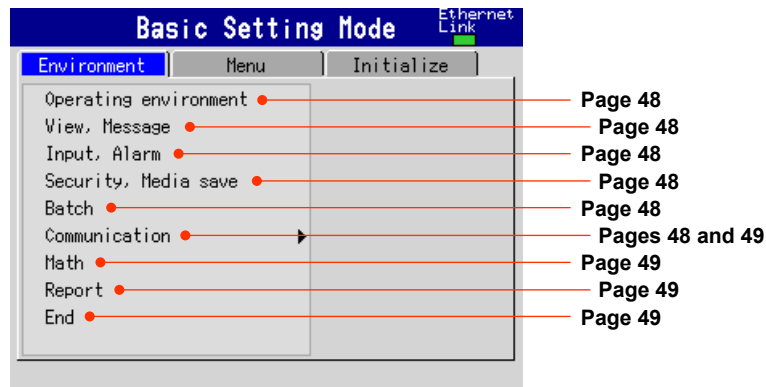

• **Menu**

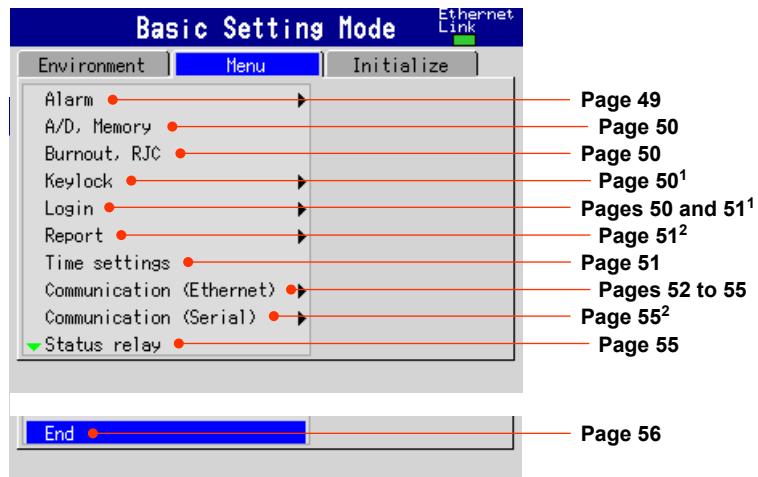

- 1 The function will be displayed if you choose to use it in **Environment**.
- 2 Optional function

• **Initialize**

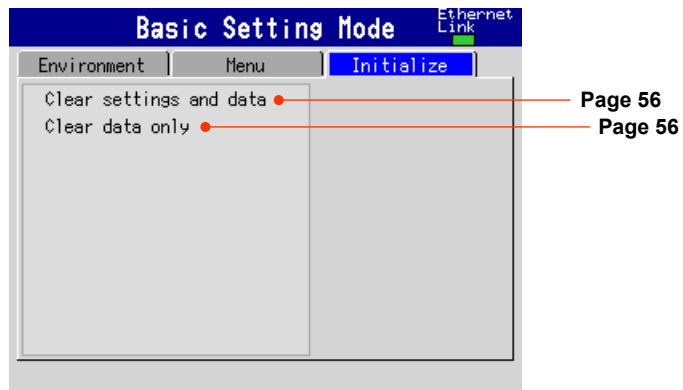

**Setting Mode Settings and Default Values**

**Menu Tab**

**Meas channel > Range, Alarm**

Setting	Selectable Range or Choices	Default Value
First-CH, Last-CH	Numeric value (channel number) 1 to 24	1
Range > Mode	Skip/Volt/TC/RTD/Scale/Delta/DI/1-5V/Sqrt	Volt
Volt		
Range	20mV/60mV/200mV/2V/6V/20V/50V	2V
Span_L	Numeric value (depends on the range)	-2.0000
Span_U	Numeric value (depends on the range)	2.0000
TC		
Range	R/S/B/K/E/J/T/N/W/L/U/WRe	R
Span_L	Numeric value (depends on the range)	0.0
Span_U	Numeric value (depends on the range)	1760.0
RTD		
Range	Pt/JPt	Pt
Span_L	Numeric value (depends on the range)	-200.0
Span_U	Numeric value (depends on the range)	600.0
Scale		
Type	Volt/TC/RTD/DI	Volt
Range	20mV/60mV/200mV/2V/6V/20V/50V (type = Volt) R/S/B/K/E/J/T/N/W/L/U/WRe (type = TC) Pt/JPt (type = RTD) Level/Cont (type = DI)	2V R Pt Level
Span_L	Numeric value (depends on the range)	-2.0000
Span_U	Numeric value (depends on the range)	2.0000
Scale_L	Numeric value (depends on the range)	0.00
Scale_U	Numeric value (depends on the range)	200.00
Unit	Character string (up to 6 characters)	—
Mode = Delta		
Type	Volt/TC/RTD/DI	Volt
Range	20mV/60mV/200mV/2V/6V/20V/50V (type = Volt) R/S/B/K/E/J/T/N/W/L/U/WRe (type = TC) Pt/JPt (type = RTD) Level/Cont (type = DI)	2V R Pt Level
Span_L	Numeric value (depends on the range)	-2.0000
Span_U	Numeric value (depends on the range)	2.0000
Ref. CH	Numeric value (measurement channel number)	001
Mode = DI		
Range	Level/Cont	Level
Span_L	Numeric value (0, 1)	0
Span_U	Numeric value (0, 1)	1
Mode = 1-5V		
Range	1-5V	1-5V
Span_L	Numeric value (0.800 to 5.200)	1.000
Span_U	Numeric value (0.800 to 5.200)	5.000
Scale_L	Numeric value (-3000 to 3000, Decimal place 0 to 4)	0.00
Scale_U	Numeric value (-3000 to 3000, Decimal place 0 to 4)	200.00
Unit	Character string (up to 6 characters)	—
Low-cut	On/Off	Off
Mode = Sqrt		
Range	20mV/60mV/200mV/2V/6V/20V/50V	2V
Span_L	Numeric value (depends on the range)	-2.0000
Span_U	Numeric value (depends on the range)	2.0000
Scale_L	Numeric value (-3000 to 3000, Decimal place 0 to 4)	0.00
Scale_U	Numeric value (-3000 to 3000, Decimal place 0 to 4)	200.00
Unit	Character string (up to 6 characters)	—
Low-cut	On/Off	Off
Value	0.0 to 5.5 %	0.5

Setting	Selectable Range or Choices	Default Value
Range > Alarm 1 to 4	On/Off	Off
Type	H/L/h/l/R/r/T/t	H
Value	Numeric value	0.000
Relay	On/Off	Off
No.	I01 to I06, S01 to S30	I01
Detect	On/Off	On

### Meas channel > Tag, Memory, Delay

Setting	Selectable Range or Choices	Default Value
Meas channel > Range, Alarm	Numeric value (channel number) 1 to 24	1
Tag > Characters	Character string (up to 16 characters)	—
Memory sample	On/Off	On
Alarm delay > Time	Numeric value (1 to 3600) s	10

### Meas channel > Moving average

Setting	Selectable Range or Choices	Default Value
First-CH, Last-CH	Numeric value (channel number) 1 to 24	1
On/Off	On/Off	Off
Count	Numeric value (2 to 400)	2

### Meas channel > Color

Setting	Selectable Range or Choices	Default Value
Group of channel	001–006/007–012/013–018/019–024	001-006
Color	Red/Green/Blue/B.violet/Brown/Orange/Y.green/ Lightblue/Violet/Gray/Lime/Cyan/Darkblue/Yellow/ Lightgray/Purple/Black/Pink/L.brown/L.green/ Darkgray/Olive/DarkCyan/S.green	Colors assigned in order to groups Red to orange

### Meas channel > Zone, Scale

Setting	Selectable Range or Choices	Default Value
First-CH, Last-CH	Numeric value (channel number) 1 to 24	1
Zone > Lower	Numeric value (0 to 95) %	0
Zone > Upper	Numeric value (5 to 100) %	100
Scale > Position	Off/1/2/3/4/5/6	1
Scale > Division	4/5/6/7/8/9/10/11/12/C10	10

### Meas channel > Bar graph

Setting	Selectable Range or Choices	Default Value
First-CH, Last-CH	Numeric value (channel number) 1 to 24	1
Base position	Normal/Center/Lower/Upper	Normal
Division	4/5/6/7/8/9/10/11/12	10

### Meas channel > Alarm mark

Setting	Selectable Range or Choices	Default Value
First-CH, Last-CH	Numeric value (channel number) 1 to 24	1
On/Off	On/Off	Off
Expand	Numeric value (1 to 99)%	50
Boundary	Numeric value (minimum span value + 1 digit to maximum span value – 1 digit)	0.0000

## Default MV1000 Settings

### Meas channel > Alarm mark

Setting	Selectable Range or Choices	Default Value
First-CH, Last-CH	Numeric value (channel number) 1 to 24	1
Mark kind	Alarm/Fixed	Alarm
Indicate on Scale	On/Off	Off
Alarm mark color > Alarm 1 to 4	Red/Green/Blue/B.violet/Brown/Orange/Y.green/Lightblue/Violet/Gray/Lime/Cyan/Darkblue/Yellow/Lightgray/Purple/Black/Pink/L.brown/L.green/Darkgray/Olive/DarkCyan/S.green	Alarm 1: Red Alarm 2: Orange Alarm 3: Orange Alarm 4: Red

### Meas channel > Color scale band

Setting	Selectable Range or Choices	Default Value
First-CH, Last-CH	Numeric value (channel number) 1 to 24	1
Band area	Off/In/Out	Off
Color	Same as the mark color	Lime
Display position > Lower	Numeric value (measurement range)	0.0000
Display position > Upper	Numeric value (measurement range)	0.0100

### Meas channel > Calibration correction

Setting	Selectable Range or Choices	Default Value
First-CH, Last-CH	Numeric value (channel number) 1 to 24	1
Number of set points	Off/2/3/4/5/6/7/8/9/10/11/12/13/14/15/16	Off
MES val	Value in the measuring range/measured value	-2.0000
True val	Numeric value (measurement range)	-2.0000

### Math channel > Expression, Alarm

Setting	Selectable Range or Choices	Default Value
First-CH, Last-CH	Numeric value (computation channel number) 101 to 124	101
Math	On/Off	Off
Calculation expression	Character string (up to 120 characters)	01
Span Lower	Numeric value (-9999999 to 99999999, Decimal place 0 to 4)	-200.00
Span Upper	Numeric value (-9999999 to 99999999, Decimal place 0 to 4)	200.00
Unit	Character string (up to 6 characters)	—
Alarm > 1 to 4	On/Off	Off
Type	H/L/T/t	H
Value	Numeric value	0.00
Relay	On/Off	Off
No.	I01 to I06/S01 to S30	I01
Detect	On/Off	On

### Math channel > Constant

Setting	Selectable Range or Choices	Default Value
Number of constant	K01-K60	K01
Input	Numeric value (-9.9999E+29 to -1.0000E-30, 0, 1.0000E-30 to -9.9999E+29)	1

### Math channel > Tag, Memory, Delay

Setting	Selectable Range or Choices	Default Value
First-CH, Last-CH	Numeric value (computation channel number) 101 to 124	101
Tag > Characters	Character string (up to 16 characters)	—
Memory sample > On/Off	On/Off	On
Alarm delay > Time	Numeric value (1 to 3600) s	10



**Math channel > TLOG, Rolling average**

Setting	Selectable Range or Choices	Default Value
First-CH, Last-CH	Numeric value (computation channel number) 101 to 124	101
TLOG	Timer type Timer No. Sum scale Reset	Timer 1 Off Off
Rolling average	On/Off Interval Number of samples	Off 10s 1

**Math channel > Color**

Setting	Selectable Range or Choices	Default Value
Group of channel	101–106/107–112/113–118/119–124	101-106
Color	Red/Green/Blue/B.violet/Brown/Orange/Y.green/ Lightblue/Violet/Gray/Lime/Cyan/Darkblue/Yellow/ Lightgray/Purple/Black/Pink/L.brown/L.green/ Darkgray/Olive/DarkCyan/S.green	Colors assigned in order to groups. Red to orange

**Math channel > Zone, Scale**

Setting	Selectable Range or Choices	Default Value
First-CH, Last-CH	Numeric value (computation channel number) 101 to 124	101
Zone	Lower Upper	0 100
Scale	Position Division	1 10

**Math channel > Bar graph**

Setting	Selectable Range or Choices	Default Value
First-CH, Last-CH	Numeric value (computation channel number) 101 to 124	101
Base position	Normal/Center/Lower/Upper	Normal
Division	4/5/6/7/8/9/10/11/12	10

**Math channel > Partial**

Setting	Selectable Range or Choices	Default Value
First-CH, Last-CH	Numeric value (computation channel number) 101 to 124	101
On/Off	On/Off	Off
Expand	Numeric value (1 to 99) %	50
Boundary	Numeric value (minimum span value + 1 digit to maximum span value – 1 digit)	0.00

**Math channel > Alarm mark**

Setting	Selectable Range or Choices	Default Value
First-CH, Last-CH	Numeric value (computation channel number) 101 to 124	101
Mark kind	Alarm/Fixed	Alarm
Indicate on Scale	On/Off	Off
Alarm mark color > Alarm 1 to 4	Red/Green/Blue/B.violet/Brown/Orange/Y.green/ Lightblue/Violet/Gray/Lime/Cyan/Darkblue/Yellow/ Lightgray/Purple/Black/Pink/L.brown/L.green/ Darkgray/Olive/DarkCyan/S.green	Alarm mark color 1: Red Alarm mark color 2: Orange Alarm mark color 3: Orange Alarm mark color 4: Red

## Default MV1000 Settings

### Math channel > Color scale band

Setting	Selectable Range or Choices	Default Value
First-CH, Last-CH	Numeric value (computation channel number) 101 to 124	101
Band area	Off/In/Out	Off
Color	Red/Green/Blue/B.violet/Brown/Orange/Y.green/ Lightblue/Violet/Gray/Lime/Cyan/Darkblue/ Yellow/Lightgray/Purple/Black/Pink/L.brown/ L.green/Darkgray/Olive/DarkCyan/S.green	Lime
Display position > Lower	Numeric value (measurement range)	0.00
Display position > Upper	Numeric value (measurement range)	1.00

### Math channel > Math start action

Setting	Selectable Range or Choices	Default Value
Math start action > Math start	Off/Start/Reset+Start	Start

### Data save > File settings

Setting	Selectable Range or Choices	Default Value
Disp/Event File > File format	Binary/Text	Binary
File header > Characters	Character string (up to 50 characters)	—
Data file name	Structure	Date
	Identified strings	—

### Data save > Save directory

Setting	Selectable Range or Choices	Default Value
Directory name	Character string (up to 20 characters)	DATA0

### Data save > Disp data

Setting	Selectable Range or Choices	Default Value
Disp data	Trend/Storage interval	5s/10s/15s/30s/1min/2min/5min/10min/15min/ 20min/30min/1h/2h/4h/10h (/div)
	Save interval	10min/20min/30min/1h/2h/3h/4h/6h/8h/12h/1day/ 2day/3day/5day/7day/10day/14day/31day

### Data save > Event data

Setting	Selectable Range or Choices	Default Value
Sample rate	25ms/125ms/250ms/500ms/1s/2s/5s/10s/30s/ 1min/2min/5min/10min (varies depending on the model)	1s
Mode	Free/SingleTrigger/RepeatTrigger	Free
Data length	10min/20min/30min/1h/2h/3h/4h/6h/8h/12h/1day/ 2day/3day/5day/7day/10day/14day/31day	1h
Pre-trigger	0/5/25/50/75/95/100 %	0
Trigger signal > Key	On/Off	On

### Data save > Batch text

Setting	Selectable Range or Choices	Default Value
Text field number	1/2/3/4/5/6/7/8	1
Title of field	Character string (up to 20 characters)	—
Characters	Character string (up to 30 characters)	—

**Display > Trend**

Setting	Selectable Range or Choices	Default Value
Direction	Horizontal/Vertical/Wide/Split	Wide
Trend clear	On/Off	On
Message direction	Horizontal/Vertical	Horizontal
Scale > Digit	Normal/Fine	Normal
Scale > Value indicator	Mark/Bargraph	Mark
Trend line	1/2/3 dot	2
Grid	Auto/4/5/.../11/12 div	Auto
Second interval	5s/15s/10s/30s/1min/2min/5min/10min/15min/20min/ 30min/1h/2h/4h/10h	1min

**Display > Bar graph**

Setting	Selectable Range or Choices	Default Value
Direction	Horizontal/Vertical	Vertical

**Display > LCD**

Setting	Selectable Range or Choices	Default Value
Brightness	1/2/3/4/5/6/7/8	2
Backlight saver	Mode Saver time Restore	Off 1min/2min/5min/10min/30min/1h Key/Key+Alm

**Display > Monitor**

Setting	Selectable Range or Choices	Default Value
Background	Display Historical trend	White Black
Scroll time	5s/10s/20s/30s/1min	10s
Jump default display	Off/1min/2min/5min/10min/20min/30min/1h	Off

**Display > HISTORY Key action**

Setting	Selectable Range or Choices	Default Value
Action	History/Favorite	History
Group display	Current/Saved	Saved
Time axis zoom	Current/Saved	Saved

**Group set, Trip line**

Setting	Selectable Range or Choices	Default Value
Group number	1/2/3/.../9/10	1
Group set	On/Off	On (group 1 to 4) Off (group 5 to 10)
Group name	Character string (up to 16 characters)	GROUP 1
CH set	Character string (channel number designation, up to 39 characters)	001.002.003.004.005.006 (varies depending on the model)
Trip line	1 to 4	Off
Position	Numeric value (0 to 100 %)	50
Color 1 to 4	Red/Green/Blue/B.violet/Brown/Orange/Y.green/ Lightblue/Violet/Gray/Lime/Cyan/Darkblue/Yellow/ Lightgray/Purple/Black/Pink/L.brown/L.green/ Darkgray/Olive/DarkCyan/S.green	Color 1: Red Color 2: Green Color 3: Blue Color 4: Yellow
Width	1/2/3 dot	2

## Default MV1000 Settings

### Message

Setting	Selectable Range or Choices	Default Value
Message No.	1–10/11–20/21–30/31–40/41–50/51–60/61–70/71–80/81–90/91–100	1–10
Characters	Character string (up to 32 characters)	—

### Timer, Event action > Timer

Setting	Selectable Range or Choices	Default Value
Timer No.	1/2/3/4	1
Mode	Off/Relative/Absolute	Off
Mode > Relative		
Interval	Numeric value (00:01 to 24:00)	01:00
Reset at Math Start	On/Off	On
Mode > Absolute		
Interval	1min/2min/3min/4min/5min/6min/10min/12min/15min/20min/30min/1h/2h/3h/4h/6h/8h/12h/24h	1h
Ref.time	Numeric value (0 to 23)	0

### Timer, Event action > Match time timer

Setting	Selectable Range or Choices	Default Value
Timer number	1/2/3/4	1
Kind	Off/Day/Week/Month/Year	Off
Kind > Day		
Day	Numeric value (1 to 28)	1
Hour:Minute	Numeric value (00:00 to 23:59)	00:00
Timer action	Single/Repeat	Repeat
Kind > Week		
Day of the week	SUN/MON/TUE/WED/THU/FRI/SAT	SUN
Hour:Minute	Numeric value (00:00 to 23:59)	00:00
Timer action	Single/Repeat	Repeat
Kind > Month		
Day	Numeric value (1 to 28)	1
Hour:Minute	Numeric value (00:00 to 23:59)	00:00
Timer action	Single/Repeat	Repeat
Kind > Year		
Month	JAN/FEB MAR/APR/MAY/JUN/JUL/AUG/SEP/OCT/NOV/DEC	1
Day	Numeric value (1 to 31)	1
Hour:Minute	Numeric value (00:00 to 23:59)	00:00
Timer action	Single/Repeat	Repeat

## Timer, Event action &gt; Event action

Setting	Selectable Range or Choices	Default Value
Logic box number	1/2/3/4/.../39/40	1
Event	None/Remote/Relay/Switch/Timer/MatchTimeTimer/Alarm/UserKey	None
Event > Remote		
Remote number	1/2/3/4/5/6/7/8	1
Action	MemoryStart/Stop, MemoryStart, MemoryStop, Trigger, AlarmACK, MathStart/Stop, MathStart, MathStop, MathReset, SaveEvent, Message, Snapshot, ManualSample, TimerReset, DisplayGroupChange, Flag, PanelLoad, TimeAdjust, DisplayFreeze/Active, MemoryClear	DisplayGroupChange
Event > Relay		
Relay number	I01/.../I06 (varies depending on the options)	I01
Action	MemoryStart/Stop, MemoryStart, MemoryStop, Trigger, MathStart/Stop, MathStart, MathStop, MathReset, SaveEvent, Message, Snapshot, ManualSample, TimerReset, DisplayGroupChange, Flag	DisplayGroupChange
Event > Switch		
Switch No.	S01/S02/S03/.../S29/S30	S01
Action	MemoryStart/Stop, MemoryStart, MemoryStop, Trigger, MathStart/Stop, MathStop, MathReset, SaveEvent, Message, Snapshot, ManualSample, TimerReset, DisplayGroupChange, Flag	DisplayGroupChange
Event > Timer		
Timer No.	1/2/3/4	1
Action	MemoryStart/Stop, MemoryStart, MemoryStop, Trigger, AlarmACK, MathStart/Stop, MathStart, MathStop, MathReset, SaveEvent, Message, Snapshot, ManualSample, DisplayGroupChange, Flag	DisplayGroupChange
Event > MatchTimeTimer		
Timer No.	1/2/3/4	1
Action	MemoryStart/Stop, MemoryStart, MemoryStop, Trigger, AlarmACK, MathStart/Stop, MathStart, MathStop, MathReset, SaveEvent, Message, Snapshot, ManualSample, TimerReset, DisplayGroupChange, Flag	DisplayGroupChange
Event > Alarm		
Action	MemoryStart/Stop, MemoryStart, MemoryStop, Trigger, MathStart/Stop, MathStart, MathStop, MathReset, SaveEvent, Message, Snapshot, ManualSample, TimerReset, DisplayGroupChange, Flag	DisplayGroupChange
Event > UserKey		
Action	MemoryStart/Stop, MemoryStart, MemoryStop, Trigger, AlarmACK, MathStart/Stop, MathStart, MathStop, MathReset, SaveEvent, Message, Snapshot, ManualSample, TimerReset, DisplayGroupChange, Flag	DisplayGroupChange

## Default MV1000 Settings

### Menu customize > Function menu

Setting	Choices
Pause Display	Select/Hide
Message	
Free message	
Media eject	
Snap shot	
Manual sample	
AlarmACK	
LCD Saver	
Trigger	
Save display	
Save event	
Save stop	
Math Start	
Math reset	
Math ACK	
Timer rest	
Match T Reset	
Keylock	
Logout	
Password change	
Second speed	
Batch	
Text field	
Favorite regist	
Standard display	
System info	
Network info	
SNTP	
E-Mail start	
E-Mail test	
FTP test	

### Menu customize > Display menu

Setting	Sub Menu	Choices
ESC		Select/Hide
TREND	GROUP1 to GROUP10 ALL CHANNEL AUTO ZONE ON/OFF SCALE ON/OFF FINE GRID ON/OFF DIGITAL ON/OFF MESSAGE DISP 1/2 TREND SPACE ON/OFF AUTO SCROLL ON/OFF	
TREND HISTORY	GROUP1 to GROUP10	
DIGITAL	GROUP1 to GROUP10 AUTO SCROLL ON/OFF	
BAR	GROUP1 to GROUP10 AUTO SCROLL ON/OFF	
OVERVIEW	CURSOR ON/OFF JUMP TO ALM SUM JUMP TO TREND JUMP TO DIGITAL JUMP TO BAR	

Setting	Sub Menu	Choices
INFORMATION	ALARM SUMMARY	Select/Hide
	MESSAGE SUMMARY	
	MEMORY SUMMARY	
	MODBUS CLIENT	
	MODBUS MASTER	
	RELAY	
	REPORT DATA	
	COLUMN BAR	
	TO HISTORY	
	TO HISTORY(DISP)	
	TO HISTORY(EV)	
	TO OVERVIEW	
	CHANGE SORT KEY	
	ASCENDING/DESCENDING ORDER	
	DATA SAVE MODE	
	SELECT SAVE	
	M.SAMPLE SAVE	
	REPORT SAVE	
	ALL SAVE	
	CHANGE DISP ITEM	
	CHANGE DATA KIND	
	FILENAME/TIME DISPLAY	
	CHANGE REPORT CH	
	DUAL/SINGLE GRAPH	
	SELECT COLUMN	
	REPORT GROUP 1 to REPORT GROUP4	
LOG	LOGIN	
	ERROR	
	COMMUNICATION	
	FTP	
	MAIL	
	WEB	
	SNTP	
	DHCP	
	MODBUS	

### Date/Time > Date & Time

Setting	Selectable Range or Choices	Default Value
Time set	—	08/01/01

### Date/Time > Daylight Saving Time

Setting	Selectable Range or Choices	Default Value
Use/Not	Use/Not	Use
Start time		
Month	JAN/FEB/MAR/APR/MAY/JUN/JUL/AUG/SEP/ OCT/NOV/DEC	3
Day order	1st/2nd/3rd/4th/Last	2nd
Day of the week	SUN/MON/TUE/WED/THU/FRI/SAT	SUN
Hour of the day	0 to 23	2
End time		
Month	JAN/FEB/MAR/APR/MAY/JUN/JUL/AUG/SEP/ OCT/NOV/DEC	11
Day order	1st/2nd/3rd/4th/Last	1st
Day of the week	SUN/MON/TUE/WED/THU/FRI/SAT	SUN
Hour of the day	0 to 23	1

## Basic Setting Mode Settings and Default Values

### Environment Tab

#### Operating environment

Setting	Selectable Range or Choices	Default Value
Operating environment		
Tag/Channel	Tag/Channel	Tag
Language	English/Japanese/German/French/Chinese/Korean	English
Temperature	C/F	C
Decimal Point Type	Point/Comma	Point

#### View, Message

Setting	Selectable Range or Choices	Default Value
View		
Trend type	T-Y	T-Y
Partial	On/Off	Off
Trend rate switching	On/Off	Off
Message		
Write group	Common/Separate	Common
Power-fail message	On/Off	Off
Change message	On/Off	Off

#### Input, Alarm

Setting	Selectable Range or Choices	Default Value
Input		
Value on over-range	Free/Over	Free
alarm		
No logging	On/Off	Off

#### Security, Media save

Setting	Selectable Range or Choices	Default Value
Security		
Key	Off/Login/Keylock	Off
Communication	Off/Login	Off
Save		
Auto save	On/Off	On
Media FIFO	On/Off	Off

#### Batch

Setting	Selectable Range or Choices	Default Value
Batch		
On/Off	On/Off	Off
Lot-No. digit	Off/4/6/8	6
Auto increment	On/Off	On

#### Communication > Service port

Setting	Selectable Range or Choices	Default Value
Service port		
FTP	Numeric value (1 to 65535)	21
HTTP	Numeric value (1 to 65535)	80
SNTP	Numeric value (1 to 65535)	123
Modbus	Numeric value (1 to 65535)	502



**Communication > POP3 Details**

Setting	Selectable Range or Choices	Default Value
POP3 Details		
Send delay [second]	0 to 10 s	2
POP3 Login	PLAIN/APOP	PLAIN

**Math**

Setting	Selectable Range or Choices	Default Value
Math		
Value on Error	+Over/-Over	+Over
Value on Overflow > SUM, AVE	Error/Skip/Limit	Skip
Value on Overflow > MAX, MIN, P-P	Over/Skip	Over

**Report**

Setting	Selectable Range or Choices	Default Value
Report		
Report select > 1	Max/Min/Ave/Sum/Inst	Ave
Report select > 2	Off/Max/Min/Ave/Sum/Inst	Max
Report select > 3	Off/Max/Min/Ave/Sum/Inst	Min
Report select > 4	Off/Max/Min/Ave/Sum/Inst	Sum
File type	Separate/Combine	Separate

**End**

Setting	Selectable Range or Choices	Default Value
Do you want to store and make the new settings take effect?	Yes/No/Cancel	—

**Menu Tab****Alarm > Basic settings**

Setting	Selectable Range or Choices	Default Value
Basic setting		
Reflash	On/Off	Off
Rate of change > Decrease	1 to 32	1
Rate of change > Increase	1 to 32	1
Indicator	Hold/Nonhold	Nonhold

**Alarm > Switch, Relay**

Setting	Selectable Range or Choices	Default Value
Internal Switch		
AND	None/S01/S01-S02/.../S01-S29/S01-S30	None
Relay		
AND	None/I01/I01-I02/.../I01-I06	None
Action	Energize/De-energize	Energize
Hold	Hold/Nonhold	Nonhold
Relay Action on ACK	Normal/Reset	Normal

**Alarm > Hysteresis**

Setting	Selectable Range or Choices	Default Value
Hysteresis		
Meas CH > High/Low	Numeric value (0.0 to 5.0)	0.5
Meas CH > Delta High/Low	Numeric value (0.0 to 5.0)	0.0
Math CH > High/Low	Numeric value (0.0 to 5.0)	0.0

## Default MV1000 Settings

### A/D, Memory

Setting	Selectable Range or Choices	Default Value
Scan interval > Scan mode	Normal/Fast	Normal
Normal > Scan interval	125ms/250ms (MV1004, MV1008) 1s/2s/5s (MV1006, MV1012, MV1024)	125ms 1s
Normal > A/D integrate	Auto/50Hz/60Hz	Auto
Fast > Scan interval	25ms (MV1004, MV1008) 125ms (MV1006, MV1012, MV1024)	25ms 125ms
Fast > A/D integrate	600Hz	600Hz
Memory		
Data kind	Display/E+D/Event	Event

### Burnout, RJC

Setting	Selectable Range or Choices	Default Value
First-CH, Last-CH	1/2/3/.../23/24 (varies depending on the model)	1
Burnout set	Off/Up/Down	Off
RJC		
Mode	Internal/External	Internal
Volt	Numeric value (-20000 to 20000) $\mu$ V	0

### Keylock > Password, Key action, Media

Setting	Selectable Range or Choices	Default Value
Password	Character string (up to 8 characters)	*****
Key action		
START/STOP	Free/Lock	Free
HISTORY	Free/Lock	Free
MENU	Free/Lock	Free
USER	Free/Lock	Free
DISP/ENTER	Free/Lock	Free
T/DIV	Free/Lock	Free
Media/USB		
External media	Free/Lock	Free
Load settings	Free/Lock	Free

### Keylock > Action of Function

Setting	Selectable Range or Choices	Default Value
Action of Function	Character string (up to 8 characters)	*****
AlarmACK	Free/Lock	Free
Message/Batch	Free/Lock	Free
Math	Free/Lock	Free
Data save	Free/Lock	Free
E-mail/FTP	Free/Lock	Free
Time set	Free/Lock	Free
Display Function	Free/Lock	Free

### Login > Basic settings

Setting	Selectable Range or Choices	Default Value
User basic settings		
Auto logout	Off/1min/2min/5min/10min	Off
Operation without Login	Off/Display	Off

### Login > Admin settings

Setting	Selectable Range or Choices	Default Value
Admin number	1/2/3/4/5	1
Mode	Off/Key/Key+Comm	Off
User name	Character string (up to 20 characters)	Admin1, etc.
Password	Character string (up to 8 characters)	???????

**Login > User settings**

Setting	Selectable Range or Choices	Default Value
User number	1/2/3/.../29/30	1
Mode	Off/Key/Comm/Web/Key+Comm	Off
User name	Character string (up to 20 characters)	User1, etc.
Password	Character string (up to 8 characters)	????????
Authority of user	Off/1/2/3/4/5/6/7/8/9/10	Off

**Login > Authority of user > Key action, Media**

Setting	Selectable Range or Choices	Default Value
Authority of user	1/2/3/4/5/6/7/8/9/10	1
Key action		
START/STOP	Free/Lock	Free
HISTORY	Free/Lock	Free
MENU	Free/Lock	Free
USER	Free/Lock	Free
DISP/ENTER	Free/Lock	Free
T/DIV	Free/Lock	Free
Media/USB		
External media	Free/Lock	Free
Load settings	Free/Lock	Free

**Login > Authority of user > Action of Function**

Setting	Selectable Range or Choices	Default Value
Authority of user	1/2/3/4/5/6/7/8/9/10	1
Action of Function		
AlarmACK	Free/Lock	Free
Message/Batch	Free/Lock	Free
Math	Free/Lock	Free
Data save	Free/Lock	Free
E-mail/FTP	Free/Lock	Free
Time set	Free/Lock	Free
Display Function	Free/Lock	Free

**Report > Basic settings**

Setting	Selectable Range or Choices	Default Value
Report set		
Report kind	Off/Hour/Day/H+D/Day+Week/Day+Month	Off
Date	Numeric value (1 to 28)	1
Day of the week	SUN/MON/TUE/WED/THU/FRI/SAT	SUN
Time (hour)	Numeric value (0 to 23)	0:00

**Report > Report settings**

Setting	Selectable Range or Choices	Default Value
Report channel number	R01/R02/R03/.../R23/R24 (varies depending on the model)	R01
On/Off	On/Off	Depends on the model
Channel	Numeric value (channel number)	001, etc.
Sum scale	Off, /s, /min, /h, /day	/s

**Time settings**

Setting	Selectable Range or Choices	Default Value
Time settings		
Time zone(HHMM)	Numeric value (-1300 to 1300)	900
Time deviation limit	Off/10s/20s/30s/1min/2min/3min/4min/5min	30s
Date format	Y/M/D, M/D/Y, D/M/Y, D.M.Y	Y/M/D

## Default MV1000 Settings

### Communication (Ethernet) > IP-address

Setting	Selectable Range or Choices	Default Value
IP-address		
DHCP	Use/Not	Not
DNS accession	Use/Not	Use
Host-name register	Use/Not	Use
Fixed IP-address > IP-address	Numeric value (0.0.0.0 to 255.255.255.255)	0.0.0.0
Fixed IP-address > Subnet mask	Numeric value (0.0.0.0 to 255.255.255.255)	0.0.0.0
Fixed IP-address > Default gateway	Numeric value (0.0.0.0 to 255.255.255.255)	0.0.0.0

### Communication (Ethernet) > Host settings

Setting	Selectable Range or Choices	Default Value
Host settings		
Host name	Character string (up to 64 characters)	—
Domain name	Character string (up to 64 characters)	—

### Communication (Ethernet) > DNS settings

Setting	Selectable Range or Choices	Default Value
Server search order		
Primary	Numeric value (0.0.0.0 to 255.255.255.255)	0.0.0.0
Secondary	Numeric value (0.0.0.0 to 255.255.255.255)	0.0.0.0
Domain suffix search order		
Primary	Character string (up to 64 characters)	—
Secondary	Character string (up to 64 characters)	—

### Communication (Ethernet) > Keep alive, Timeout

Setting	Selectable Range or Choices	Default Value
Keep alive	On/Off	On
Application time out		
On/Off	On/Off	Off
Time	Numeric value (1 to 120) (min)	1

### Communication (Ethernet) > Server

Setting	Selectable Range or Choices	Default Value
Server		
FTP	Use/Not	Not
Web	Use/Not	Use
SNTP	Use/Not	Not
Modbus	Use/Not	Not

### Communication (Ethernet) > Web page

Setting	Selectable Range or Choices	Default Value
Page type	Operator/Monitor	Operator
When Page type is Operator		
On/Off	On/Off	Off
Access control	Off/Admin	Off
Command	Use/Not	Not
When Page type is Monitor		
On/Off	On/Off	Off
Access control	Off/Admin/User	Off

**Communication (Ethernet) > E-Mail > Basic settings**

Setting	Selectable Range or Choices	Default Value
Basic settings		
SMTP server name	Character string (up to 64 characters)	—
Port number	Numeric value (0 to 65535)	25
Security	Off/PbS	Off

**Communication (Ethernet) > E-Mail > Recipients**

Setting	Selectable Range or Choices	Default Value
Recipients		
Recipient 1	Character string (up to 150 characters)	—
Recipient 2	Character string (up to 150 characters)	—
Sender	Character string (up to 64 characters)	—

**Communication (Ethernet) > E-Mail > POP3 settings**

Setting	Selectable Range or Choices	Default Value
POP3 Settings		
POP3 Server name	Character string (up to 64 characters)	—
Port number	Numeric value (0 to 65535)	110
Login name	Character string (up to 32 characters)	—
Password	Character string (up to 32 characters)	*****...***

**Communication (Ethernet) > E-Mail > Alarm settings**

Setting	Selectable Range or Choices	Default Value
Alarm settings		
Recipient 1	On/Off	Off
Recipient 2	On/Off	Off
Active Alarms > Alarm 1	On/Off	Off
Active Alarms > Alarm 2	On/Off	Off
Active Alarms > Alarm 3	On/Off	Off
Active Alarms > Alarm 4	On/Off	Off
Include INST	On/Off	Off
Include source URL	On/Off	Off
Subject	Character string (up to 32 characters)	Alarm_summary
Header 1	Character string (up to 64 characters)	—
Header 2	Character string (up to 64 characters)	—

**Communication (Ethernet) > E-Mail > Scheduled settings**

Setting	Selectable Range or Choices	Default Value
Scheduled settings		
Recipient 1	On/Off	Off
Interval	1h/2h/3h/4h/6h/8h/12h/24h	24h
Ref.time	Numeric value (00:00 to 23:59)	00:00
Recipient 2	On/Off	Off
Interval	1h/2h/3h/4h/6h/8h/12h/24h	24h
Ref.time	Numeric value (00:00 to 23:59)	00:00
Include INST	On/Off	Off
Include source URL	On/Off	Off
Subject	Character string (up to 32 characters)	Periodic_data
Header 1	Character string (up to 64 characters)	-
Header 2	Character string (up to 64 characters)	-

## Default MV1000 Settings

### Communication (Ethernet) > E-Mail > System settings

Setting	Selectable Range or Choices	Default Value
System settings		
Recipient 1	On/Off	Off
Recipient 2	On/Off	Off
Include source URL	On/Off	Off
Subject	Character string (up to 32 characters)	System_warning
Header 1	Character string (up to 64 characters)	—
Header 2	Character string (up to 64 characters)	—

### Communication (Ethernet) > E-Mail > Report settings

Setting	Selectable Range or Choices	Default Value
Report settings		
Recipient 1	On/Off	Off
Recipient 2	On/Off	Off
Include source URL	On/Off	Off
Subject	Character string (up to 32 characters)	Report_data
Header 1	Character string (up to 64 characters)	—
Header 2	Character string (up to 64 characters)	—

### Communication (Ethernet) > FTP client > FTP transfer file

Setting	Selectable Range or Choices	Default Value
FTP transfer file		
Disp&Event data	On/Off	Off
Report	On/Off	Off
Snapshot	On/Off	Off

### Communication (Ethernet) > FTP client > FTP connection

Setting	Selectable Range or Choices	Default Value
FTP connection		
Server name	Primary/Secondary	Primary
Port number	Character string (up to 64 characters)	—
Login name	Numeric value (0 to 65535)	21
Password	Character string (up to 32 characters)	—
Account	Character string (up to 32 characters)	***** ... ***
PASV mode	Character string (up to 32 characters)	—
Initial path	On/Off	Off
	Character string (up to 64 characters)	—

### Communication (Ethernet) > SNMP client

Setting	Selectable Range or Choices	Default Value
SNMP client		
Use/Not	Use/Not	Not
Server name	Character string (up to 64 characters)	—
Port number	Numeric value (0 to 65535)	123
Access interval	Off/1h/8h/12h/24h	8h
Access reference time	Numeric value (00:00 to 23:59)	00:00
Access timeout	10s/30s/90s	30s
Time adjust on Start action	On/Off	Off

### Communication (Ethernet) > Modbus client > Basic settings

Setting	Selectable Range or Choices	Default Value
Modbus client basic settings		
Read cycle	125ms/250ms/500ms/1s/2s/5s/10s	1s
Retry interval	Off/10s/20s/30s/1min/2min/5min/10min/20min/30min/1h	2min

**Communication (Ethernet) > Modbus client > Modbus server settings**

Setting	Selectable Range or Choices	Default Value
Server number	1-8/9-16	1-8
Port	Numeric value (0 to 65535)	502
Modbus server name	Character string (up to 64 characters)	—
Unit	Auto/Fixed	Auto
No.	0 to 255	1

**Communication (Ethernet) > Modbus client > Command settings**

Setting	Selectable Range or Choices	Default Value
Master command number	1-8/9-16	1-8
1 to 16	Off/R-M/W/W-M	Off
First	Varies depending on the send command type	—
Last	Varies depending on the send command type	—
Server	1/2/3/.../15/16	1
Regi.	Numeric value (register number)	R-M: 30001 W, W-M: 40001
Type	INT16/UIN16/INT32_B/INT32_L/UIN16_B/ UIN16_L/FLOAT_B/FLOAT_L	R-M, W: INT16 W-M: INT32_B

**Communication (Serial) > Basic settings**

Setting	Selectable Range or Choices	Default Value
Serial		
Baud rate	1200/2400/4800/9600/19200/38400	9600
Data length	7/8	8
Parity	Odd/Even/None	Even
Handshaking	Off/Off/XON:XON/XON:RS/CS:RS	Off/Off
Address	Numeric value (1 to 99)	1
Protocol	Normal/Modbus/Modbus-M	Normal

**Communication (Serial) > Modbus master > Basic settings**

Setting	Selectable Range or Choices	Default Value
Modbus master basic settings		
Read cycle	125ms/250ms/500ms/1s/2s/5s/10s	1s
Timeout	125ms/250ms/500ms/1s/2s/5s/10s/1min	1s
Retrials	Off/1/2/3/4/5/10/20	1
Inter-block delay	Off/5ms/10ms/15ms/45ms/100ms	Off
Auto recovery	Off/1min/2min/5min/10min/20min/30min/1h	2min

**Communication (Serial) > Modbus master > Command settings**

Setting	Selectable Range or Choices	Default Value
Master command number	1-8/9-16	1-8
1 to 16	Off/R-M/W/W-M	Off
First	Varies depending on the send command	—
Last	Varies depending on the send command	—
Addr.	Numeric value (1 to 247)	1
Regi.	Numeric value (register number)	R-M: 30001 W, W-M: 40001
Type	INT16/UIN16/INT32_B/INT32_L/UIN16_B/ UIN16_L/FLOAT_B/FLOAT_L	R-M, W: INT16 W-M: INT32_B

## Default MV1000 Settings

---

### Status relay

Setting	Selectable Range or Choices	Default Value
Status relay		
Memory/Media status	On/Off	Off
Measurement error	On/Off	Off
Communication error	On/Off	Off
Memory stop	On/Off	Off

---

### End

Setting	Selectable Range or Choices	Default Value
Do you want to store and make the new settings take effect?	Yes/No/Cancel	—

---

## Initialize Tab

### Clear settings and data

Setting	Selectable Range or Choices	Default Value
Are you sure you want to initialize "Settings + Measure&Math data"?	Yes/No	—

---

### Clear data only

Setting	Selectable Range or Choices	Default Value
Are you sure you want to initialize "Measure&Math data"?	Yes/No	—

---